

EVENT DIRECTORY

eastec®

A Manufacturing Technology Series Event

MAY 14–16, 2019

EASTERN STATES EXPOSITION | WEST SPRINGFIELD, MA



Official Media Partner

sme
MEDIA

Manufacturing
ENGINEERING
SMART
manufacturing



MANUFACTURING
TECHNOLOGY SERIES

produced by
sme & AMT

VISIT US AT BOOTH #2034



FANUC | RoboDrill Plus-K

- Standard "Bolt-on" Solution
- Standardized workholding means minimal setups
- Rotary carousel stores tools and parts for automatic loading
- Increase the tool capacity by up to 96 tools
- Holds up to 60 parts



FANUC | RoboCut C400iB

- World's Most Reliable Wire EDM
- Best Auto Threader on the Market
- X/Y/Z Travels: 15.7" X 10.6" x 10" (400mm x 270mm x 250mm)
- Core-Stitch Function
- Anti-Recast Power Supply
- Tilt / Rotary Axis Available

Showrooms and Technical Centers

Boston • Charlotte • Chicago • Detroit
Los Angeles • Memphis • Phoenix • San Francisco

 **Methods**
877-668-4262 | www.methodsmachine.com

EXPERIENCE THE DIFFERENCE

High End Technology Available for Citizen Machines

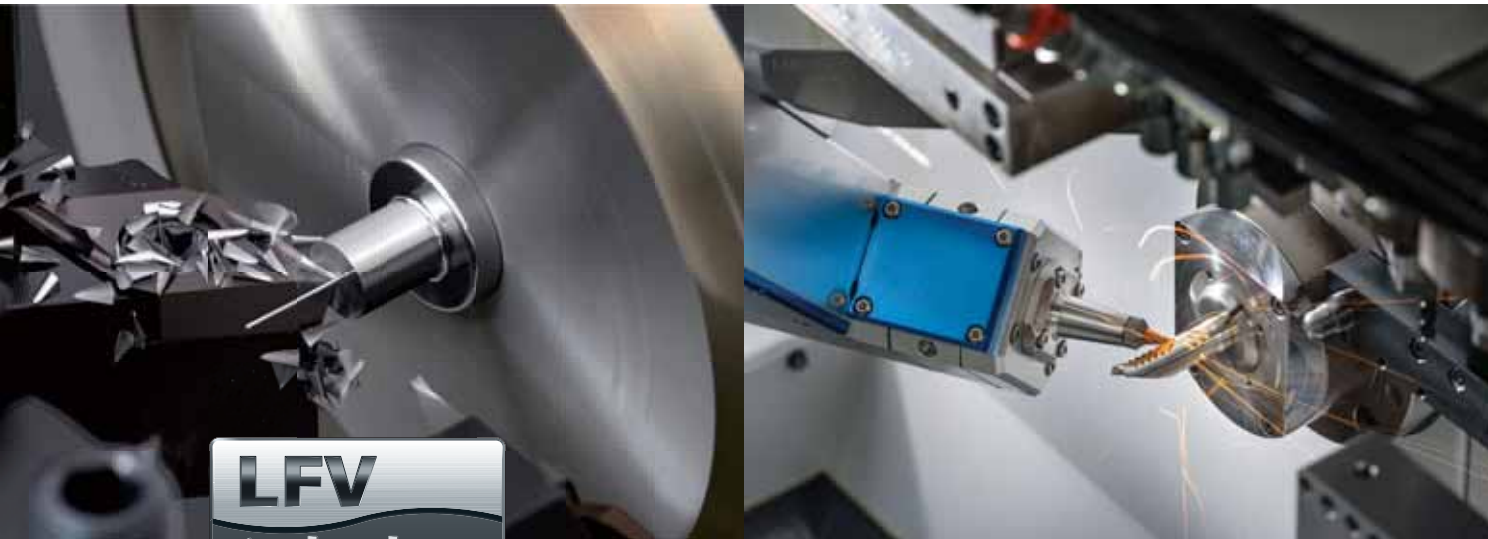

LFV
technology

Low Frequency Vibration (LFV) technology from Citizen

Avoid the problem of spiraling chips, entanglement of chips and built-up edges

- Handles broad range of shapes and materials
- Ideal for difficult-to-cut materials
- Increases tool life
- Reduces heat generation and power consumption

eastec[®]

See us at Booth #1406

Laser System L2000 – THE Complete Manufacturing System

Laser Cutting, Welding and Conventional Machining on a Single Machine

- Faster than EDM machining
- Minimal burrs
- Near endless geometric shape possibilities
- Internal pulse generator with endless parameter possibilities
- Head assembly is completely liquid tight

CONTENTS

2	Welcome
4	General Information
7	Sponsors & Supporters
10	Event At-A-Glance
14	Featured Presentations
20	Special Programs & Activities
34	Speaker Biographies
40	Exhibitor Quick Reference
47	Event Map
48	Floor Plan
52	New Products
55	Exhibitor List—Alphabetical
97	Exhibitor List—Product Categories
124	Ad Index

WELCOME TO EASTEC 2019!

Now in its 36th year, EASTEC is a vital event for Northeastern manufacturers and we strive to provide an excellent ROI for exhibitors and attendees.

Spend time with us in the new **SME ZONE** in Building 1, where our speakers and presenters will break down the barriers you're facing and help you learn faster and more efficiently. They will address critical topics from the Industrial Internet of Things to cyber-security, automation and intelligent robotics, workforce development and training, and sustainability.

Take advantage of all the opportunities to see, learn and experience:

- **Opening Day Keynote: Inspiring Innovation and Sustainability with Stanley Black & Decker**—Marty Guay, vice president, Business Development, Stanley Black & Decker, will focus on Stanley Black & Decker's collaboration with startups to grow the manufacturing community.
- **Keynote Panel: Engage a Multi-General Workforce for Sustainable Manufacturing**—Manufacturers need to implement strong on-boarding and mentoring programs, along with new learning and development programs that align to each generation. This panel will explore various examples from industry and how they are meeting the challenge.
- **Smart Manufacturing Hub**—This area showcases the industry's most advanced smart technologies, including 3D printing, automation, 3D scanning, and more. Insightful technical presentations combined with resources from leading providers will bring you up to speed quickly.

Download the EASTEC mobile app, where you can access event details, receive important updates and participate in giveaways. To download the app, search for EASTEC in your mobile phone's app store.

Along with smart manufacturers like you, we will continue to advance manufacturing technology and attract future generations to our industry. We encourage you to visit sme.org and amtonline.org to learn more about how SME and AMT can be your resource.

Again, on behalf of SME and AMT, welcome to EASTEC 2019, and thank you for attending.

Sincerely,

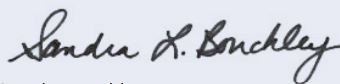

Sandi Bouckley
Executive Director & CEO
SME



Doug Woods
President
AMT- The Association For
Manufacturing Technology

Carbide Where It Matters

KenTIP™ FS

Drill Point Innovation.

We put carbide where it is truly needed: At the very front of the drill body. Provides protection from chip flow and workpiece contact.

Chip Flow Innovation.

Ultra-high polished chip flutes ensure hassle-free chip evacuation, enhancing tool life and boost the drilling performance.

Coolant Supply Innovation.

Coolant where it is most needed: At the drill point, and to the rake face. Drilling stainless steel with ease.



kennametal.com/KENTIPFS



Easy to select, easy to order, easy to apply, exceptional performance.
kennametal.com/FirstChoice

Visit us at Booth #5563

Exposition Hours

ALL BUILDINGS

Tuesday, May 14	9:00 am – 5:00 pm
Wednesday, May 15	9:00 am – 5:00 pm
Thursday, May 16	9:00 am – 3:00 pm

Registration Hours

THE REGISTRATION BARN

Tuesday, May 14	8:00 am – 4:00 pm
Wednesday, May 15	8:00 am – 4:00 pm
Thursday, May 16	8:00 am – 2:00 pm

Registration Fees

The registration fee (*for persons not already registered*) for the EASTEC exposition is \$50 (free to SME members with a valid member card or to persons with an exhibitor guest pass). Fee is payable by cash, check or credit card in US funds. Registration begins daily at 8:00 am in the Registration Barn.

Your EASTEC show badge admits you to all four exhibit buildings, keynote presentations and the educational presentations in the Theater (located in the SME ZONE).

EASTEC is a business event. No one under 18 years of age admitted.

Information Desk Locations—“Ask Me” Stations

Get answers to your questions in the crossover between Building #1 and #2, the Registration Barn or the Show Office in Building #5.

Media Center

Located in the SME ZONE, Building 1 #1164.

SME ZONE

Located in Building #1 in Booth #1164

The SME ZONE is the nerve center of everything happening at EASTEC. Major attractions will be hosted in the SME ZONE – and while you’re there, learn how SME can help you grow your business and advance your career. SME can help you keep up with advancing technology, maintain your innovative edge, develop your workforce, help you close the skills gap, connect you with the manufacturing industry and expand your network, and much more. Manufacturing comes with challenges; SME offers solutions. When you visit the SME ZONE, you can:

- Catch all the EASTEC keynotes, panel discussions and industry experts, hosted in our theater;
- Get a sneak peak of manufacturing’s leaders and top thinkers from across every segment recording podcasts with SME Media;
- Sign up to potentially get 10 free online learning and development classes from Tooling U-SME;
- Nominate a deserving student, colleague, friend or employee for Manufacturing Engineering’s “30 Under 30” Award, which recognizes the brightest and most promising stars of our industry who are making a difference in manufacturing even from the beginning of their careers; and
- Engage with SME representatives to learn more about our organization, its mission, our education foundation, member resources, and how SME can provide you the resources you need to grow your career and grow your business.

EASTEC Mobile App

Download the EASTEC mobile app to your phone or tablet. The EASTEC app is your go-to guide for everything that’s happening at EASTEC. View the schedule, make your own personalized agenda, engage with other attendees and exhibitors, access social media, see the show floor and more.*



Free WiFi Network: BigE-Hotspot
Access Code: eastec

*SME does not guarantee continuous WiFi or cell phone service.

EASTECC Social Media

Find EASTECC on Facebook, Twitter and LinkedIn. Use #EASTECC19 to join the discussion and see what's happening throughout the event.

New Products

A number of new products are being introduced at EASTECC – technologies to help you better serve your customers and run a more competitive operation. EASTECC features nearly 50 product categories. You can find these new products listed on the website and in the EASTECC mobile app.

Important Telephone Numbers

SHOW OFFICES

Building #1 (NAC)

Phone: 413.205.5544

Building #1 (SME ZONE)

Phone: 413.205.5554

Building #5 (BLC - Better Living Center)

Phone: 413.205.5549

Concession Areas

Please note: All food vendors now accept cash or credit cards.

BUILDINGS #1 & #2 (INSIDE)

Eddie Shore Enterprises Concession & Zena's Café

Tuesday, May 14 7:00 am – 5:00 pm

Wednesday, May 15 7:00 am – 5:00 pm

Thursday, May 16 7:00 am – 3:00 pm

BUILDING #3 (INSIDE)

West Side Grille

Tuesday, May 14 7:00 am – 5:00 pm

Wednesday, May 15 7:00 am – 5:00 pm

Thursday, May 16 7:00 am – 3:00 pm

BUILDING #5 (INSIDE)

Glass House 1, 2 and Dunkin' Donuts

Tuesday, May 14 7:00 am – 5:00 pm

Wednesday, May 15 7:00 am – 5:00 pm

Thursday, May 16 7:00 am – 3:00 pm

OUTSIDE (BETWEEN BUILDINGS #3 AND #5)

Butcher Boys, NY Pizza, Crow's Nest Mexican, Soup-R-Bowl, Pig Park BBQ

Tuesday, May 14 - Thursday, May 16 11:00 am – 3:00 pm

ATMs

Building #2 Located near the restrooms between Buildings #1 and #2

Building #3 Located just inside Door 1

Building #5 Located just inside Door 6

Coat Check / Bag Drop

The Coat Check / Bag Drop is located in the Stroh Building (Building 4) in the same door as Exhibitor Services. It will be open on show days at the following times:

Tuesday, May 14 9:00 am – 5:00 pm

Wednesday, May 15 9:00 am – 5:00 pm

Thursday, May 16 9:00 am – 3:00 pm

Lost Badges

Lost show badges may be claimed or reprinted in the Registration area in the Already Registered Barn.

Lost & Found

Items turned in to Show Management can be claimed at the Security Office located in the crossover between Buildings #1 and #2 on the 2nd floor.

First Aid

Emergency care and assistance is available during show hours in Building #5 in the 500 aisle.

While You're In West Springfield ...

The Greater Springfield Convention and Visitors Bureau will be on-site at EASTEC to assist you with restaurant reservations and provide details on places to visit. Stop by the bureau's table in the Registration area (located in Registration Barn and the Already Registered Barn) to receive coupons for area restaurants and businesses, a walking map and more.

Visit explorewesternmass.com.

Complimentary Hotel Shuttle

PICKUP LOCATIONS

- Courtyard by Marriott West Springfield
- Hampton Inn West Springfield
- Hilton Garden Inn Springfield
- Holiday Inn Express Springfield Downtown
- MGM Springfield,
- Residence Inn West Springfield
- Sheraton Springfield at Monarch Place
- Tower Square Hotel Springfield

INBOUND TO EASTERN STATES EXPOSITION

Tuesday, May 14 - 7:45 am - 10:00 am (last hotel departure at 10:00 am)

Wednesday, May 15 - 7:45 am - 10:00 am (last hotel departure at 10:00 am)

Thursday, May 16 - 7:45 am - 10:00 am (last hotel departure at 10:00 am)

RETURN TO HOTELS

Tuesday, May 14 1:15 pm - 6:45 pm

Wednesday, May 15 1:15 pm - 7:30 pm

Thursday, May 16 1:15 pm - 4:00 pm

On-Site Parking Shuttle

The on-site parking shuttle will pick you up from the attendee parking area coming in gate A and take you to the entrance of the event.

Tuesday, May 14 10:00 am - 6:45 pm

Wednesday, May 15 10:00 am - 7:45 pm

Thursday, May 16 10:00 am - 4:00 pm

Program Changes Disclaimer

SME reserves the right to make last-minute speaker changes. SME is not responsible for incidental expenses incurred by registered participants.

Photography Policy

No photos without permission of the exhibitor.

Solicitation/Suitcasing Policy

Solicitation by non-exhibitors is not permitted.

Tax Deduction

An income tax deduction may be allowed for education expenses (including registration fees, travel, lodging and meals) undertaken to improve professional skills (see Treas. Reg. Sec 1.162-5).

Special Requirements



SME is committed to providing reasonable accommodation to persons with disabilities who require such accommodation in order to fully participate in SME-sponsored events. For details, contact the EASTEC Show Offices in Building #1 (413.205.5544) or Building #5 (413.205.5549).

ABOUT SME



SME connects manufacturing professionals, academia and communities, sharing knowledge and resources to build

inspired, educated and prosperous manufacturers and enterprises. With more than 85 years of experience and expertise in events, media, membership, training and development, and through an education foundation, SME is committed to promoting manufacturing technology, developing a skilled workforce and attracting future generations to advance manufacturing. Learn more at sme.org.

ABOUT AMT – THE ASSOCIATION FOR MANUFACTURING TECHNOLOGY



The Association For Manufacturing Technology (AMT) represents and promotes US-based manufacturing

technology and its members – those who design, build, sell and service the continuously evolving technology that lies at the heart of manufacturing. Founded in 1902 and based in Virginia, the association specializes in providing targeted business assistance, extensive global support, and business intelligence systems and analysis. AMT is the voice that communicates the importance of policies and programs that encourage research and innovation, and the development of educational initiatives to create tomorrow's Smartforce. AMT owns and manages IMTS, the International Manufacturing Technology Show, which is the premier manufacturing technology event in North America. For more information, visit AMTonline.org.

MANUFACTURING TECHNOLOGY SERIES



Bringing together four strategic manufacturing events – HOUSTEX, EASTEC, SOUTH-TEC and WESTEC – under one umbrella.

A NEW APPROACH. ENDLESS OPPORTUNITIES.

The Manufacturing Technology Series creates a consistent platform to ensure an unparalleled experience. The Manufacturing Technology Series brings decision makers from diverse industries together with leading suppliers of advanced manufacturing technology, equipment and tooling.

Located in key manufacturing hubs, the Manufacturing Technology Series events showcase the latest equipment and processes along with breakthrough technologies associated with artificial intelligence, 3D printing/additive manufacturing, robotics, automation, and Big Data. For more information, visit sme.org/manufacturing-technology-series.

ABOUT SME MEDIA



SME Media is a leading source for news and in-depth technical information about advanced

manufacturing in North America. It serves an audience of more than 100,000 manufacturing professionals who subscribe to its magazines, iTunes app, industry yearbooks, e-newsletters and other media products. Coverage is focused on some of the world's most critical industries: aerospace and defense, motorized vehicles, medical manufacturing and energy, including oil and gas, nuclear, electric, solar and wind.

ABOUT TOOLING U-SME



Tooling U-SME delivers versatile, competency-based learning and development solutions to the manu-

facturing community, working with thousands of companies including more than half of all Fortune 500® manufacturing companies, as well as 600 educational institutions across the country. Tooling U-SME partners with customers to build high performers who help their companies drive quality, productivity, innovation, and employee satisfaction. Working directly with hundreds of high schools, community colleges, and universities, Tooling U-SME is also able to help prepare the next generation workforce by providing industry-driven curriculum. A division of SME, an organization that connects people to manufacturing solutions, Tooling U-SME can be found at toolingu.com.

ABOUT THE SME EDUCATION FOUNDATION



The SME Education Foundation inspires, prepares and supports students in their quest for roles as engineers and

technologists in advanced manufacturing. Our unique Partnership Response In Manufacturing Education (PRIME®) initiative makes high school students across the country aware of STEM opportunities and teaches, prepares and advances their pursuit of those opportunities. That career readiness is an important step in addressing a national skills gap: 2 million jobs will go unfilled in the next decade due to an alarming lack of skilled, qualified talent. We also administer and award numerous annual scholarships to deserving students as they pursue associate and bachelor's degree studies. Our scholarships create opportunity for the next generation of advanced manufacturing technicians, technologists and engineers. Visit www.smeef.org to learn more about our mission and how you can get involved.

Thank you to the following sponsors and partners that have made EASTEC 2019 possible.

SPONSORS AND SUPPORTERS



EASTEC SUPPORTERS



MEDIA SPONSORS



MEDIA PARTNERS



It's easy to say your tooling solves problems.
It's harder to prove it.
We prove it every day.

Stuck on a tough tooling challenge? Let us help.

Heimatec isn't just a world leader in live tools, angle heads and multi-spindle drill heads; we're your source for problem solving and tooling application expertise.

With years of hands-on experience and the most innovative tooling, we are your **TOTAL** solution source.

Put us to the test and send us your toughest tooling challenge.



16 E. Piper Lane, Prospect Heights, IL
Suite 128 • 847-749-0633
info@platinumtooling.com
www.platinumtooling.com

See us at Booth #5146

EASTEC 2019 At-A-Glance

TUESDAY, MAY 14 | SHOW HOURS: 9:00 AM – 5:00 PM

Time	Event	Location
9:00 AM – 5:00 PM	SME ZONE	Bldg 1 #1164
9:00 AM – 5:00 PM	Augmented Reality Experience (Sponsored by Makino)	Bldg 5 #5258
9:15 – 10:15 AM	Keynote: Inspiring Innovation and Sustainability <i>Marty Guay, Stanley Black & Decker</i>	SME ZONE Bldg 1 #1164
10:00 – 10:15 AM	Knowledge Bar: Automating Part Gauging for High-Mix, Small-Batch Manufacturing <i>David Henderson, New Scale Robotics</i>	SME ZONE Bldg 1 #1164
10:20 – 11:00 AM	Adapt Your Manufacturing Process: Do More with Less <i>Mark Sumner, Acieta</i>	Smart Manufacturing Hub Bldg 5 #5375
10:30 – 11:05 AM	Simulation Advancements in “Industry 4.0” <i>Serge Viau, CGTech</i>	SME ZONE Bldg 1 #1164
10:45 AM – 12:45 PM	Workshop: Getting Started with Metal & Hybrid Additive Manufacturing: An Overview & Outlook <i>Jeffrey Crandall and Henry Babiec, CCAT - Connecticut Center for Advanced Technology, Inc.</i>	Bldg 3, Room 1
10:45 AM – 12:45 PM	Workshop: The KISS Method to Automation <i>Corey Carolla, Red Rabbit Automation</i>	Bldg 3, Room 2
11:00 – 11:15 AM	Knowledge Bar: Deburring Holes Efficiently with ECM <i>Mike Hively, EMAG, LLC</i>	SME ZONE Bldg 1 #1164
11:15 – 11:50 AM	How to Reduce Sheet Metal Design Risks and Production Costs <i>Jamie White, Protolabs</i>	SME ZONE Bldg 1 #1164
11:20 AM – 12:00 PM	A Deep Dive into Metal 3D Printing <i>George Morar, Protolabs</i>	Smart Manufacturing Hub Bldg 5 #5375
12:00 – 1:15 PM	Lunch and Learn: Unique Tooling Solutions for Maximizing Productivity <i>Jack Kohler, Greenleaf Corporation</i> (Sponsored by Greenleaf Corporation)	SME ZONE Bldg 1 #1164
12:20 – 1:00 PM	The Future of Manufacturing: Growing Your Job Shop in Industry 4.0 <i>Jason T. Ray, Paperless Parts</i>	Smart Manufacturing Hub Bldg 5 #5375
1:20 – 2:00 PM	Not Your Father's CMM – New Generation CMMs Solve Two Problems <i>Milan Kocic, Hexagon Manufacturing Intelligence</i>	Smart Manufacturing Hub Bldg 5 #5375
1:25 – 2:00 PM	Holistic Plastic Part Design <i>Dr. Keith Hechtel, DBA, Curbell Plastics, Inc.</i>	SME ZONE Bldg 1 #1164
2:00 – 2:15 PM	Knowledge Bar: Benefits of Engineered Surface Finishes <i>Sanjai Keshavan, Nagel Precision, Inc.</i>	SME ZONE Bldg 1 #1164
2:00 – 4:00 PM	Workshop: The Keys To Industry 4.0 Success: Why Most Projects Fail and How You Can Learn From Their Mistakes <i>Eric Fogg, MachineMetrics</i>	Bldg 3, Room 1
2:00 – 4:00 PM	Workshop: Impactful Marketing Tactics for Manufacturers <i>Chris Ciunci, TribalVision</i> (Sponsored by TribalVision)	Bldg 3, Room 2

TUESDAY, MAY 14 SHOW HOURS: 9:00 AM – 5:00 PM (CONTINUED)		
Time	Event	Location
2:10 – 2:45 PM	Workpiece Stabilization and Non-Traditional Fixturing for Machining, Welding and Other Processes <i>John Zaya, BIGKAISER Precision Tooling, Inc.</i>	SME ZONE Bldg 1 #1164
2:20 – 3:00 PM	The Industrialization of Metal Additive Manufacturing; Some Days are Diamonds; Some Days are Rocks <i>Graham F. Boyd, SLM Solutions</i>	Smart Manufacturing Hub Bldg 5 #5375
2:55 – 3:30 PM	Machine Learning Classification for Tool Life Modeling Using Production Shop-Floor Tool Wear Data <i>Peng Li, GE Global Research Center</i>	SME ZONE Bldg 1 #1164
3:00 – 3:15 PM	Knowledge Bar: Milling Strategies for Challenging Aerospace Parts <i>Evan Duncanson, Emuge Corp.</i>	SME ZONE Bldg 1 #1164
3:20 – 4:00 PM	Making Shop Workflow Accessible and Easy to Digest <i>Vahid Kalhori, Sandvik Applied Manufacturing Technologies</i>	Smart Manufacturing Hub Bldg 5 #5375
4:20 – 5:00 PM	5 Steps to Success: Cashing in on the Promise of Data-Driven Manufacturing <i>David McPhail, MEMEX Inc.</i>	Smart Manufacturing Hub Bldg 5 #5375
5:00 – 6:30 PM	New England Manufacturing Networking Reception (Sponsored by Eastern States Exposition and Mastercam)	Outside/Tented Area
WEDNESDAY, MAY 15 SHOW HOURS: 9:00 AM – 5:00 PM		
Time	Event	Location
8:00 AM – 5:00 PM	Additive Manufacturing Series Seminar: Additive Manufacturing Materials	Carriage House at Eastern States Exposition
9:00 AM – 5:00 PM	Augmented Reality Experience (Sponsored by Makino)	Bldg 5 #5258
9:15 – 10:15 AM	Keynote: Riding the Crest: Economic Outlook <i>Alan Beaulieu, ITR Economics</i> (Sponsored by Chubb Insurance)	SME ZONE Bldg 1 #1164
10:00 – 10:15 AM	Knowledge Bar: Understanding Welding Procedure Qualifications <i>Burt Riendeau, Airgas USA, LLC</i>	SME ZONE Bldg 1 #1164
10:20 – 11:00 AM	Preparing for the Loss of Your Go-To Guy: Make Your Know-How Digital to Stay Competitive and Always be Prepared for Change <i>Jenny Hörnlund, Sandvik Applied Manufacturing Technologies</i>	Smart Manufacturing Hub Bldg 5 #5375
10:30 – 11:05 AM	Tooling Life in the Age of Regulation: Life After Chlorinated Paraffins <i>Hoon Kim, BASF/Chemetall</i>	SME ZONE Bldg 1 #1164
10:45 AM – 12:45 PM	Workshop: AR, VR, MR, or xR? Making Sense of the Extended Realities That Fit Your Engineering and Manufacturing Enterprise <i>Eric Kam, ESI Group</i>	Bldg 3, Room 2
11:00 – 11:15 AM	Knowledge Bar: Traditional vs. Modern ERP Platforms <i>Christopher Shadbolt, Genius ERP</i>	SME ZONE Bldg 1 #1164

EASTEC 2019 At-A-Glance

WEDNESDAY, MAY 15 SHOW HOURS: 9:00 AM – 5:00 PM (CONTINUED)		
Time	Event	Location
11:15 – 11:50 AM	Fiber-Reinforced 3D Printed DLP Parts for Use in Injection Mold Tooling <i>Karlo Delos Reyes, Fortify</i>	SME ZONE Bldg 1 #1164
11:20 AM – 12:00 PM	The Industrialization of Metal Additive Manufacturing; Some Days are Rocks; Some Days are Diamonds <i>Graham F. Boyd, SLM Solutions</i>	Smart Manufacturing Hub Bldg 5 #5375
11:30 AM – 2:30 PM	SME Chapter Roundtable	TBD
12:00 – 1:15 PM	Lunch and Learn: Optimizing CNC Machine Tooling and Increasing Productivity by 10–40% <i>Robbie McKee, JM Performance Products, Inc.</i> (Sponsored by JM Performance Products, Inc.)	SME ZONE Bldg 1 #1164
12:20 – 1:00 PM	Unlock the Power of Data Hidden in Your Job Shop <i>Jason T. Ray, Paperless Parts</i>	Smart Manufacturing Hub Bldg 5 #5375
1:20 – 2:00 PM	AI in Manufacturing: The Rise of the Augmented Human and the Thinking Machine <i>John Canosa, Augmentir</i>	Smart Manufacturing Hub Bldg 5 #5375
1:25 – 2:00 PM	The Future of Robotic Welding <i>Pete Rogers, Acieta</i>	SME ZONE Bldg 1 #1164
2:00 – 2:15 PM	Knowledge Bar: Alloy Development for Additive Manufacturing <i>Aaron LaLonde, PhD, SLM Solutions</i>	SME ZONE Bldg 1 #1164
2:00 – 4:00 PM	Workshop: Business Bootcamp: How Successful Organizations are Increasing Engagement, Execution, and Earnings <i>Shane Yount, Competitive Solutions, Inc.</i>	Bldg 3, Room 1
2:00 – 4:00 PM	Workshop: Advanced Functionality for Modern Controls <i>Rick Schultz and Frank Nuqui, FANUC America</i>	Bldg 3, Room 2
2:10 – 2:45 PM	Advantages of Waterjet Technology: Versatility, Efficiency, and Productivity <i>Brian Sherick, Flow International</i>	SME ZONE Bldg 1 #1164
2:20 – 3:00 PM	How to Reduce Sheet Metal Design Risks and Production Costs <i>LaShawn LeBaron, Protolabs</i>	Smart Manufacturing Hub Bldg 5 #5375
2:55 – 3:30 PM	Techniques to Effectively EDM Bi-Metal Cavities <i>Robert Fothergill, POCO Graphite, an Entegris Company</i>	SME ZONE Bldg 1 #1164
3:00 – 3:15 PM	Knowledge Bar: Reducing Electrode Wear in Aerospace & Molding Industries <i>Jim Weirido, MC Machinery Systems/Mitsubishi EDM</i>	SME ZONE Bldg 1 #1164
3:20 – 4:00 PM	Adapt Your Manufacturing Process: Do More with Less <i>Mark Sumner, Acieta</i>	Smart Manufacturing Hub Bldg 5 #5375
4:20 – 5:00 PM	Fueling Continuous Improvement with Real-Time Data: The Underlying ROI/Business Case <i>David McPhail, MEMEX, Inc.</i>	Smart Manufacturing Hub Bldg 5 #5375
5:00 – 7:00 PM	SME President's Reception Celebrating our Customers	SME ZONE Bldg 1 #1164

THURSDAY, MAY 16 | SHOW HOURS: 9:00 AM – 3:00 PM

Time	Event	Location
8:00 AM – 2:00 PM	Student Summit	Bldg 4
9:00 – 9:15 AM	Department of Defense Manufacturing Challenge	SME ZONE Bldg 1 #1164
9:00 AM – 3:00 PM	Augmented Reality Experience <i>(Sponsored by Makino)</i>	Bldg 5 #5258
9:15 – 10:15 AM	Keynote Panel: Engage a Multi-Generational Workforce for Sustainable Manufacturing	SME ZONE Bldg 1 #1164
9:20 – 10:00 AM	The Industrialization of Metal Additive Manufacturing; Some Days are Diamonds; Some Days are Rocks <i>Graham F. Boyd, SLM Solutions</i>	Smart Manufacturing Hub Bldg 5 #5375
10:00 – 10:15 AM	Knowledge Bar: Solving QC Bottlenecks via Walk-Up Metrology <i>Rick Lasure, The L.S. Starrett Company</i>	SME ZONE Bldg 1 #1164
10:20 – 11:00 AM	Automated and Robotic Near-Line and In-Line 3D Inspection Solutions <i>Treb Quesinberry, Metrologic Group</i>	Smart Manufacturing Hub Bldg 5 #5375
10:30 – 11:05 AM	Automation for Coating Operations: Specialty Movements <i>Martin Powell, Carlisle Fluid Technologies</i>	SME ZONE Bldg 1 #1164
10:45 – 11:45 AM	Apprenticeships in Massachusetts: Resource Support for Manufacturers <i>Leslie Parady, MassMEP</i>	Storrowton Tavern at Eastern States Exposition
10:45 AM – 12:45 PM	Workshop: Creating a Successful Lean Transformation <i>Pete Winiarski, Win Enterprises, LLC</i>	Bldg 3, Room 1
11:00 – 11:15 AM	Knowledge Bar: Why Vacuum Heat Treating? <i>Tim Steber, Solar Atmospheres</i>	SME ZONE Bldg 1 #1164
11:15 – 11:50 AM	Quality Measurement and Inspection with X-ray CT Scanning <i>Hermisno Villarraga-Gomez, PhD, Nikon Metrology, Inc.</i>	SME ZONE Bldg 1 #1164
11:20 AM – 12:00 PM	A Deep Dive into Metal 3D Printing <i>George Morar, Protolabs</i>	Smart Manufacturing Hub Bldg 5 #5375
12:00 – 1:15 PM	Lunch and Learn: Adaptive ERP for Life Sciences & Automotive Manufacturers <i>Michael Koliias and Tom Roberts, QAD Inc. (Sponsored by QAD, Inc.)</i>	SME ZONE Bldg 1 #1164
12:20 – 1:00 PM	Industry 4.0 Simplified for All: Job Shop to OEM, Quoting to Quality <i>Gregg Biglieman, PhD, Sandvik Applied Manufacturing Technologies</i>	Smart Manufacturing Hub Bldg 5 #5375
1:20 - 2:00 PM	Bridging the Customer Experience Gap to Win More Work <i>Jason T. Ray, Paperless Parts</i>	Smart Manufacturing Hub Bldg 5 #5375
1:25 – 2:00 PM	How to Reduce Operating Costs in Your Manufacturing Facility with Energy Efficiency <i>Lauren Mattison MS, CEM, and Beka Kosanovic, PhD, UMass Center for Energy Efficiency and Renewable Energy</i>	SME ZONE Bldg 1 #1164
2:00 – 2:15 PM	Knowledge Bar: Error Proofing the Tool Load Process with RFID Tool Identification <i>Mike Laurendeau, Caron Engineering, Inc.</i>	SME ZONE Bldg 1 #1164

SME ZONE is located in Bldg 1 #1164

Smart Manufacturing Hub located in Bldg 5 #5375

Workshops and the Additive Manufacturing Seminar, highlighted in blue, require a registration fee. All others are free to EASTEC attendees.

SME reserves the right to amend this program. In the event of a cancellation, SME is not responsible for incidental costs incurred by registrants. It is recommended that refundable airline tickets be purchased.

**COMPLIMENTARY
KEYNOTE PRESENTATIONS**

Located in the Theater in the SME Zone - Building 1 #1164

**Tuesday, May 14 | 9:15 - 10:15 AM
INSPIRING INNOVATION AND SUSTAINABILITY**



*Marty Guay,
Vice President, Business Development,
Stanley Black & Decker*

The Northeast was at the heart of the early Industrial Revolutions and Stanley Black & Decker is focused on reigniting that innovative ecosystem to be a leader in the Fourth Industrial Revolution. The STANLEY+Techstars Additive Manufacturing Accelerator brings early-stage, growth-driven companies to the Advanced Manufacturing Center of Excellence to collaborate through education, mentorship and financing. The innovations center on 3D printing, rapid prototyping, direct digital manufacturing, additive fabrication and eco-friendly solutions. This keynote presentation will focus on Stanley Black & Decker's collaboration with startups to grow the manufacturing community and foster innovative technology and sustainability.

**Wednesday, May 15 | 9:15 - 10:15 AM
RIDING THE CREST - ECONOMIC OUTLOOK**

Sponsored by: **CHUBB®**



*Alan Beaulieu,
President and Principal,
ITR Economics*

The economic trends are shifting. Seeing those shifts, understanding them, and setting realistic expectations for the remainder of 2019 and for 2020 will require managers to be keenly aware of the changes taking place. Thinking and planning for the changes before they are on your door step is key to being successful as we go through the business cycle. Attend and learn what the leading indicators are telling us and what it all means for manufacturing going forward.

**Thursday, May 16 | 9:15 - 10:15 AM
KEYNOTE PANEL: ENGAGE A MULTI-GENERATIONAL
WORKFORCE FOR SUSTAINABLE MANUFACTURING**



*Moderator:
Denise Ball,
Workforce Development Specialist,
Tooling U-SME*



*Panelists:
Mary Ann Pacelli,
National Program Manager,
Manufacturing Extension Partnership (MEP)*



*Michael Munday,
CEO and Owner,
Arwood Machine Corporation,*



*David Dussault,
CEO,
P1 Holdings, Inc.*

With millions of manufacturing workers expected to retire in the next few years, building your workforce is critical to the success and sustainability of manufacturing. As new employees enter the hiring pool, employers are discovering that engaging the needs of multiple generations takes thoughtful planning and new conversations. Manufacturers need to implement strong on-boarding, mentoring, along with new learning and development programs. These strategies need to align with the way these generations learn and re-think policies to attract and retain the future workforce while also capturing the knowledge from their most senior employees. This panel will explore various examples from industry and discuss how these companies are stepping up to meet the challenge.

The TRUMPF logo consists of the word "TRUMPF" in a bold, black, sans-serif font, positioned above a solid blue square. The entire logo is enclosed within a white rectangular border.

For Additive Manufacturing

Put Your Confidence in TRUMPF Laser Metal Fusion

Featuring limitless design possibilities and cost-effective production of small batch sizes, TRUMPF TruPrint laser metal fusion machines excel where traditional machining falls short. Capable of producing complex, strong and lightweight parts from a wide variety of metals, the TruPrint operates without tooling and works directly from your CAD model. Converting powdered metal into finished components can transform your parts, your products and your profitability. Put your confidence in TRUMPF – Together we can build your success.

Visit us at EASTEC - Booth 2004 and RAPID + TCT - Booth 1017 / www.trumpf.com

ADDITIVE MANUFACTURING SERIES SEMINAR

Wednesday, May 15 | 8:00 AM - 5:00 PM

Located in the Carriage House at Eastern States Exposition

ADDITIVE MANUFACTURING MATERIALS

The Additive Manufacturing Seminar Series, co-located with the EASTEC Event, focuses on advanced manufacturing technologies, tools and practices that optimize development and production. By attending the Seminar, you will join manufacturers throughout the country as they explore innovative manufacturing solutions using AM technologies, network with peers and find out what's new to help plan and execute your additive manufacturing strategy.

Learn how:

- Major manufacturers and suppliers have transformed their operations by embracing Additive Manufacturing with a focus on the materials used to produce production-ready parts
- Industry experts are implementing the technology by hearing various case studies with the real life examples of how AM is transforming traditional manufacturing
- Materials used are ever-changing and how metals, polymers and advanced composites are utilized to create final parts

Seminar registration includes:

- New England Manufacturing Networking Reception on May 14, 5:00 - 6:30 PM
- SME President's Reception on May 15, 5:00 - 7:00 PM

The following companies are scheduled to speak at the seminar.



COMPLIMENTARY EDUCATIONAL PRESENTATIONS

Located in the Theater in the SME Zone - Building 1 #1164

Tuesday, May 14 | 10:30 - 11:05 AM
SIMULATION ADVANCEMENTS IN "INDUSTRY 4.0"

Serge Viau, Sales Engineer, CGTech

Manufacturers are attempting to understand and implement the "digital twin." With more NC manufacturing data available, choosing the best data, using it efficiently, and optimizing processes are key to reducing costs and improving efficiency. Software interoperability connects CAD/CAM systems, PLM systems, tooling databases, Cloud-based downloadable resources, and CNC machines, providing realistic and accurate data. Learn how companies can make better business decisions by simulating CNC machines in a robust virtual environment (versus in reality).

11:15 - 11:50 AM
HOW TO REDUCE SHEET METAL DESIGN RISKS AND PRODUCTION COSTS

Jamie White, Product Manager, Sheet Metal, Protolabs

You're bound to encounter a few twists and turns when designing parts for sheet metal fabrication. In this presentation, we'll briefly look at the multi-step manufacturing process involved in creating sheet metal parts and the various equipment used along the way. You'll learn which part features increase production risks, the resulting design implications, and most importantly, how to reduce that risk through design iterations. We'll also discuss tactics to reduce overall production costs.

1:25 - 2:00 PM
HOLISTIC PLASTIC PART DESIGN

Dr. Keith Hechtel, DBA, Senior Director of Business Development, Curbell Plastics, Inc.

Engineering plastics have seen widespread use in demanding aerospace, military, and industrial applications. These materials have unique mechanical, electrical, and thermal properties that allow them to perform in conditions where other materials will rapidly fail. This presentation will include an overview of

CoroPlus® — harness the power of machining data.

Society's rapid digitalization brings opportunities for the manufacturing industry to overcome challenges, minimize waste of resources, time and data – and ultimately become more profitable. CoroPlus®, the digital machining offer from Sandvik Coromant, includes solutions that facilitate the manufacturing industry's journey into Industry 4.0.

Discover what CoroPlus® can do for you:
[coroplus.sandvikcoromant](https://coroplus.sandvikcoromant.com)



Visit us at Booth #1118

plastic material selection and plastic part design. A number of new plastics that offer quality improvements and cost savings compared with traditional plastics will be introduced.

2:10 – 2:45 PM

WORKPIECE STABILIZATION AND NON-TRADITIONAL FIXTURING FOR MACHINING, WELDING, AND OTHER PROCESSES

John Zaya, Product Manager - Workholding, BIGKAISER Precision Tooling Inc.

In today's marketplace where part mix is high and volumes are low, the ability for a shop to thrive requires flexibility with the ability to change at a moment's notice, all while maintaining high part quality. Fixturing requirements are becoming more complex as workpiece complexity is increasing. We will look at how parts that have traditionally posed workholding challenges are being held rigidly and securely with modern-day solutions.

2:55 – 3:30 PM

MACHINE LEARNING CLASSIFICATION FOR TOOL LIFE MODELING USING PRODUCTION SHOP-FLOOR TOOL WEAR DATA

Peng Li, Senior Principal Scientist, GE Global Research Center

Tool wear in machining is difficult to predict due to a large number of influencing variables and tool-to-tool performance variation. In this presentation, machine learning classification methods, Support Vector Machines, and Logistic, for modeling tool life using production shop-floor tool wear data will be presented. Results show good agreement with the 'true' tool life curve. A simplified method to generate synthetic data to augment sparse and unbalanced datasets is also presented.

Wednesday, May 15 | 10:30 – 11:05 AM

TOOLING LIFE IN THE AGE OF REGULATION: LIFE AFTER CHLORINATED PARAFFINS

Hoon Kim, Senior Principal R&D Scientist, BASF/Chemetall

Among various extreme pressure (EP) agents, chlorinated paraffins (CPs) have been the most popular EP additive in metalworking fluids (MWFs) due to the numerous advantages including cost effectiveness, wide activation temperature, versatility in applications, easy formulation and stability in water. But CPs have health and hazard issues. Thus, MWF manufacturers

are seeking CP alternatives. Along this line, the present report describes new organic-inorganic hybrid systems as new EP and corrosion inhibitor technology for MWF application.

11:15 – 11:50 AM

FIBER-REINFORCED 3D PRINTED DLP PARTS FOR USE IN INJECTION MOLD TOOLING

Karlo Delos Reyes, Vice President Business Development, Fortify

In order to realize inefficiencies and to iterate more frequently in the plastic prototyping process, engineers are turning to 3D printed tooling as a fast and cost-effective replacement for aluminum tools. However, typical 3D printed plastics are unable to handle the pressures or temperatures of longer injection mold runs. In our study, we investigate how incorporating reinforcing-additives, such as engineering grade ceramics, to the 3D printing resin can extend tool life.

1:25 – 2:00 PM

THE FUTURE OF ROBOTIC WELDING

Pete Rogers, Vice President of Operations, Acieta

Robotic welding systems have evolved over the years and now have the ability to take on more jobs than ever before. With added pressures of labor shortages and global competition, robotic welding technologies are giving manufacturers the ability to maintain consistent throughput and quality without increasing costs.

2:10 – 2:45 PM

ADVANTAGES OF WATERJET TECHNOLOGY: VERSATILITY, EFFICIENCY, AND PRODUCTIVITY

Brian Sherick, Vice President of North America Sales, Flow International

Regarded as the most versatile process in the world, waterjet systems allow fabricators to take on any manner of work. Waterjets complement other fabricating technologies and are becoming the process of choice for many fabricators and machine shops. You will hear how waterjet technology continues to benefit customers, using several smart approaches to maximize performance which includes productivity, cost, and accuracy driving significant gains in the manufacturing industry.

2:55 – 3:30 PM

TECHNIQUES TO EFFECTIVELY EDM BI-METAL CAVITIES

*Robert Fothergill, EDM Applications Specialist,
POCO Graphite, an Entegris Company*

To machine two metals in one detail, you must understand the physical properties and material characteristics that cause them to EDM differently. Through the study of these material characteristics and EDM testing, we have found that there are techniques that allow for efficient machining of different materials as one detail.

This session will discuss the effects of the EDM process with a bi-metal workpiece, and the detailed results of successfully machining across both materials simultaneously.

Thursday, May 16 | 10:30 – 11:05 AM

AUTOMATION FOR COATING OPERATIONS – SPECIALTY MOVEMENTS

Martin Powell, Technical Systems Specialist, Carlisle Fluid Technologies

Automation comes in many forms. We often think of robots when automation is mentioned. Many think we are taking jobs from workers when automation is used. In the search for skilled labor or any labor, companies are looking for innovative ways to automate processes.

This presentation will present other concepts of automation: reciprocators, X-Y Machines, indexing systems, automatic loading of ovens, and other specialized conveyor movements that add automation to a process.

11:15 – 11:50 AM

QUALITY MEASUREMENT AND INSPECTION WITH X-RAY CT SCANNING

*Herminso Villarraga-Gomez, X-ray CT Metrology Specialist,
Nikon Metrology, Inc*

The aim of this presentation is to illustrate the application of X-ray computed tomography (CT) not only for non-destructive inspection but also for the metrological assessment of diverse manufactured parts, particularly by using dimensional metrology (part-to-CAD comparison, wall thickness analysis, size measurements) and for material inspection (voids and defect detection). The benefits of CT for the quality assessment and inspection of new manufacturing technologies such as additive manufacturing (or 3D Printing) will be considered.

1:25 – 2:00 PM

REDUCE OPERATING COSTS IN YOUR MANUFACTURING FACILITY WITH ENERGY EFFICIENCY

Lauren Mattison, MS, CEM and

Beka Kosanovic, PhD, UMass Center for Energy and Renewable Energy

In most manufacturing facilities, there is substantial potential to reduce operating costs through improved energy efficiency. While some of these opportunities involve significant capital investments, many only require simple modifications to existing equipment or controls at little to no implementation cost. We will discuss how energy efficiency can benefit businesses, typical efficiency opportunities and best practices, how we can help eligible facilities get started with a free assessment through the U.S. Department of Energy's Industrial Assessment Center program, and a case study of a facility that saved more than \$100,000 a year based on our recommendations.

**DropZero™ 5-Axis
Modular Zero Point System**



STACKABLE

Completely machine a workpiece in one setup. Use in conjunction with Roemheld's Zero Point Mounting System.

- High accuracy
- Increased productivity

roemheld-usa.com/drop-zero

eastec
Booth 5661



ROEMHELD
HILMA ■ STARK

Carr Lane Roemheld Mfg. Co.
info@clrh.com | (636) 386-8022

WORKSHOPS

All workshops require a separate registration fee. Include a lunch voucher, beverage and EASTEC Exhibit Floor registration.
SME Member: \$125 and Non-member: \$145

Tuesday, May 14 | 10:45 AM - 12:45 PM GETTING STARTED WITH METAL & HYBRID ADDITIVE MANUFACTURING: AN OVERVIEW & OUTLOOK

This session is located in Building 3, Room 1



*Jeffrey Crandall,
Additive Manufacturing Research &
Applications Senior Engineer,
CCAT - Connecticut Center for
Advanced Technology*



*Henry Babiec, Manufacturing Applications
Engineer,
Connecticut Center for Advanced
Technology - CCAT*

Metal additive manufacturing is rapidly evolving into a set of tools available for manufacturers. At the leading edge of this evolution are hybrid machines that combine the power of metal additive manufacturing with traditional subtractive manufacturing resulting in the ability to create complex parts that neither technology can build by itself. This presentation will introduce you to hybrid manufacturing, then show you applications of the technology, and discuss how hybrid may apply to your business.

10:45 AM - 12:45 PM THE KISS METHOD TO AUTOMATION

This session is located in Building 3, Room 2



*Corey Carolla, Vice President Corporate
Development, Red Rabbit Automation*

What steps and information will help your company to see the value of robotic automation as the future for your company's manufacturing initiatives? In this workshop you will learn why automation needs to be in the corporate strategy moving forward, hear specific case studies on how to keep the process as simple and cost effective as possible, and learn the ROI potential for growth and stability moving your company into the future.

2:00 - 4:00 PM THE KEYS TO INDUSTRY 4.0 SUCCESS: WHY MOST PROJ- ECTS FAIL AND HOW YOU CAN LEARN FROM THEIR MISTAKES

This session is located in Building 3, Room 1



*Eric Fogg,
Co-Founder and COO,
MachineMetrics*

The IoT Revolution is picking up speed and as it does, it is changing the manufacturing world forever. Of the many manufacturers in pursuit of digitization, a large number are unlikely to succeed. According to a 2017 Cisco study, 74% of companies that begin an IoT initiative fail, leading to a greater hesitation for manufacturers to embark on their digital transformation journeys. So what's the secret sauce to Industry 4.0 success?

2:00 - 4:00 PM IMPACTFUL MARKETING TACTICS FOR MANUFACTURERS

This session is located in Building 3, Room 2



*Chris Ciunci,
Managing Partner,
TribalVision*

Sponsored by:  **TribalVision**
HELPING BUSINESS MARKET SMARTER

With more and more manufacturers expanding their digital footprint, your company's marketing strategy needs to have an updated toolbox of digital marketing channels and tactics. These full-funnel digital marketing efforts are essential for a manufacturer's marketing strategy.

Wednesday, May 15 | 10:45 AM - 12:45 PM

AR, VR, MR, OR xR? MAKING SENSE OF THE EXTENDED REALITIES THAT FIT YOUR ENGINEERING AND MANUFACTURING ENTERPRISE

This session is located in Building 3, Room 2



Eric Kam, Solution Market Strategist Smart Factory, ESI Group

“Industry 4.0” and “Smart Factories” initiatives have created expectations for implementation of Augmented, Virtual, and Mixed Realities (AR, VR, MR) with little explanation of the desired effect of employing the technology. When should we use augmented reality? Will AR achieve the same benefits as VR?



What extended reality (xR) platform best addresses your engineering needs? In this session, we will define these disparate technologies and work together to identify where they apply to your enterprise.

HAIMER

Quality Wins.

HAIMER Microset

Leading in technology and design – tool presetting that is worlds ahead.

- Easy to use software
- Up to ± 2 µm repeatability
- Shop floor ready (thermally stable design)
- Industry 4.0 ready
- Reduce set-up times by as much as 70%

May 14–16, 2019
Come visit us in West Springfield!
Booth #5458

eastec®

Measuring and Presetting Technology

Tooling Technology

Shrinking Technology

Balancing Technology

www.haimer-usa.com

2:00 - 4:00 PM

BUSINESS BOOTCAMP: HOW SUCCESSFUL ORGANIZATIONS ARE INCREASING ENGAGEMENT, EXECUTION, AND EARNINGS

This session is located in Building 3, Room 1



*Shane Yount,
President,
Competitive Solutions, Inc.*

Organizations have become a slave to team models that are inefficient, unproductive, and bureaucratic. As well intentioned leaders attempt to add the latest Continuous Improvement tool as a sign of forward thinking strategic commitment, sustainment and ownership is compromised due to ineffective teams. This session will challenge attendees to examine their current operating system and team functionality, while providing proven and practical solutions for improvement.

2:00 - 4:00 PM

ADVANCED FUNCTIONALITY FOR MODERN CONTROLS

This session is located in Building 3, Room 2



*Rick Schultz, Aerospace Program Manager,
FANUC America and*



*Frank Nuqui,
Aerospace Program Manager,
FANUC America*

Part manufacturing is extremely competitive requiring suppliers to constantly work on reducing cycle times while improving part accuracy and finish. Significant amounts of money are spent on tooling and external systems to try to improve processes yet very few are taking advantage of the many advanced functions available in modern controls.

Thursday, May 16 | 10:45 AM - 12:45 PM
CREATING A SUCCESSFUL LEAN TRANSFORMATION

This session is located in Building 3, Room 1



*Pete Winiarski,
CEO and Founder,
Win Enterprises, LLC*

“Lean” has unfortunately received status as a buzzword, where everyone thinks they know what lean is – yet few have truly been through a full transformation. In this session you will learn to recognize the different mistakes companies make and also learn what systems to put in place to ensure your success.

LUNCH & LEARN PRESENTATIONS

All Lunch & Learn Presentations are located in the Theater in the SME ZONE – Building 1 #1164

Tuesday, May 14 | 12:00 - 1:15 PM
UNIQUE TOOLING SOLUTIONS FOR MAXIMIZING PRODUCTIVITY

Jack Kohler, Applications Engineer, Greenleaf Corporation

Sponsored by: 

This seminar will focus on eliminating waste within customer value streams utilizing Greenleaf’s engineered solutions. These solutions include standard and special tooling that provide customers with higher productivity and help them meet cost-saving initiatives.





DREAM it. DESIGN it. SHAPE it.
shaping your dreams



EXOCARB® AERO DLC & UVX-Ti End Mills

OSG's EXOCARB® AERO DLC provides maximum performance and high efficiency processing in aluminum alloys and the EXOCARB® AERO UVX-Ti provides stable and high efficiency milling in titanium alloys. Two excellent tooling choices for your aerospace applications. Standard or special tooling, OSG designs new and innovative products specifically to shape our customers' dreams.

eastec

Booth # 5652

800-837-2223 • www.osgtool.com

Wednesday, May 15 | 12:00 - 1:15 PM OPTIMIZING CNC MACHINE TOOLING AND INCREASING PRODUCTIVITY BY 10-40%

Robbie McKee, Sales, JM Performance Products, Inc.

Sponsored by:  **JM PERFORMANCE PRODUCTS, INC.**
The Industry Leader in Milling Machine Optimization

An inherent design flaw in CAT or V-Flange tooling causes vibration and chatter, run-out, poor finishes, poor tolerances, non-repeatability, shortened tool life and excessive spindle wear and tear. We will describe how the problem can be identified in any shop and explain the causes. This presentation will illustrate how all these issues cost money and negatively affect production.

Thursday, May 16 | 12:00 - 1:15 PM ADAPTIVE ERP FOR LIFE SCIENCES & AUTOMOTIVE MANUFACTURERS

Michael Koliass, Director of Life Sciences, QAD Inc.

Tom Roberts, VP - Automotive Business Development, QAD, Inc.

Sponsored by: 

Join the exhilarating discussion on adaptive ERP for manufacturers and why you need to focus on a rapid, agile and effective solution for your company. In this session, Tom Roberts and Michael Koliass are going to take you on a journey of where companies go wrong and why having a flexible ERP in place is one of the single most important core business solutions in your company. Tom and Mike will walk through the importance of implementing technology to keep your business flourishing for years to come. Listen as they disrupt your thinking, provide you with guidance on a new way of thinking and help you push your companies potential through the ceiling during this information session. You will not want to miss it.



SMART MANUFACTURING HUB

Be sure to visit this dynamic area on the event floor that features advanced manufacturing technologies including 3D printing, inspection, measurement technologies and more. Insightful technical presentations combined with resources from leading technology providers will bring you up to speed quickly on developments in the quickly changing field.

All Smart Manufacturing Hub Presentations are located in Building 5, #5375.

**Adapt Your Manufacturing Process:
Do More with Less**

TUESDAY, MAY 14 | 10:20 - 11:00 AM
WEDNESDAY, MAY 15 | 3:20 - 4:00 PM

Mark Sumner, Vice President of Sales & Marketing, Acieta

Sponsored by: 

Fabricators today face a major paradox: high demand for faster lead time and a dwindling workforce. Integrating robotic automation into your fabrication process frees up floor space, increases productivity, all with fewer workers. Acieta will expand on the benefits of robotic automation and how to choose the right robotics integrator. Attendees will hear real examples of how automation helped one company increase their capacity by 50% by streamlining their operations.

**AI in Manufacturing - The Rise of the
Augmented Human and the Thinking
Machine**

WEDNESDAY, MAY 15 | 1:20 - 2:00 PM

John Canosa, CTO & Co-Founder, Augmentir

Sponsored by: 

The emergence of Artificial Intelligence (AI), Augmented Reality (AR), and wearable tech opens the door to connecting historically disconnected frontline workers into the digital fabric of the business. By providing frontline workers with interactive instructions and remote support we are not only guiding them to new levels of productivity and quality but are able to capture human-centric activities in real time. While this step naturally creates even more data points in an already noisy environment, AI offers the solution to converting the noise and clutter into

First Article Inspection in Minutes *On the shop floor or in the quality lab*



Verisurf Software lets you see the difference between nominal CAD and finished parts, in real-time. Perfect for in-process, first article and automated production inspection.

Verisurf Software works with ALL CAD software, and ALL CMMs, new or existing, to provide flexible inspection and reporting solutions, in the quality lab or on the shop floor.

See the difference Verisurf can make in your business by reducing training costs, increasing efficiency, reducing scrap and improving overall quality.

Let us show you the difference, in your shop, with your parts. Contact us, today.



3D Measurement Solutions

www.verisurf.com • 866-340-5551

Educators, ask about our education program.

See the Difference

See us at Booth #5050

insights that identify the largest areas of opportunity in productivity, quality, training, and operations.

In this session, John Canosa, Co-Founder and CTO of Augmentir, will share how to harvest the value from truly understanding your human-centric operations and illustrates how AI can provide rich insights into human and machine behavior that ultimately unlock the value of AR and wearable tech in industrial organizations.

Not Your Father's CMM - New Generation CMMs Solve Two Problems

TUESDAY, MAY 14 | 1:20 - 2:00 PM

Milan Kocic, Business Development Manager, UX and Innovation, Hexagon Manufacturing Intelligence

Sponsored by:  **HEXAGON**
MANUFACTURING INTELLIGENCE

The latest generation of Coordinate Measuring Machines (CMMs) is not reminiscent of your father's standard, go-to measurement solution. CMM technology has continued to evolve due to significant industry challenges - the widening metrology skills gap and the ever-increasing demand on manufacturers to get quality products out the door on time and in spec. Advanced CMM technologies have been introduced to render the modern day CMM more collaborative and autonomous to help operators execute measurement routines expeditiously.

5 Steps to Success: Cashing in on the Promise of Data-Driven Manufacturing

TUESDAY, MAY 14 | 4:20 - 5:00 PM

David McPhail - President & CEO, MEMEX Inc.

Sponsored by:  **MEMEX**
Measuring Manufacturing Excellence

Today's manufacturers are under pressure to shorten lead-times and reduce costs more than ever before and are increasingly adopting Data-Driven Manufacturing to achieve these goals. However, it is not enough for manufacturers to just monitor machines to achieve maximum efficiency and profitability. They must also ensure shop floor data is collected automatically, and in real-time, and then must analyze and act appropriately upon the data collected. In this presentation, MEMEX will use actual case studies to discuss a strategy for monetizing real-time shop floor data that is rooted in a pragmatic repeatable approach, focused on the business case and expected outcome.

Fueling Continuous Improvement with Real-time Data - The Underlying ROI / Business Case

WEDNESDAY, MAY 15 | 4:20 - 5:00 PM

David McPhail - President & CEO, MEMEX Inc.

Sponsored by:  **MEMEX**
Measuring Manufacturing Excellence

Manufacturers profiting from Data-Driven Manufacturing do so primarily because they have a well-defined strategy to incorporate real-time data into their Continuous Improvement methodologies. Data-Driven Manufacturing is transforming Kaizen, Lean, Six Sigma and other methods by shifting the emphasis from data collection and analysis to high value-added activities, rapidly evolving standard work practices. In this presentation, MEMEX will discuss a proven, cost effective strategy for achieving sustainable operational excellence through Impactful Continuous Improvement based on the collection of real-time objective data from all manufacturing assets.

Automated and Robotic Near-Line and In-Line 3D Inspection Solutions

THURSDAY, MAY 16 | 10:20 - 11:00 AM

Treb Quesinberry, Senior Application Engineer, Metrologic Group

Sponsored by:  **metrologic**
group

Metrologic Group will present its revolutionary and unique universal 3D inspection software solutions dedicated to 3D automated and robotic inspection cells that are incorporated with or near the manufacturing line: Metrolog X4 I-Robot, and its complementary offline simulation software: Silma X4 I-Robot with functionalities such as automatic path generation, tool change, collision detection and avoidance, etc.

The Future of Manufacturing: Growing Your Job Shop in Industry 4.0

TUESDAY, MAY 14TH - 12:20 - 1:00 PM

Jason T. Ray, Co-Founder and CEO, Paperless Parts

Sponsored by:  **paperlessPARTS** 

As technology evolves and manufacturing become increasingly more digital, job shops face pressure to produce faster than

ever—and shops that aren't equipped with the right tools may not be able to keep up. We'll take you through the essential digital tools your shop needs to be more productive, increase revenue and grow the business.

Unlock the Power of Data Hidden in Your Job Shop

WEDNESDAY, MAY 15 | 12:20 - 1:00 PM

Jason T. Ray, Co-Founder and CEO, Paperless Parts

Sponsored by: **paperlessPARTS** 

Estimates show that 33% of data generated by job shops can drive business insights, yet, manufacturers use only 0.5% on average. Learn how to leverage the data you already have as an advantage to drive revenue growth.

Bridging The Customer Experience Gap to Win More Work

THURSDAY, MAY 16 | 1:20 - 2:00 PM

Jason T. Ray, Co-Founder and CEO, Paperless Parts

Sponsored by: **paperlessPARTS** 

The customer is king: improving your customer experience is the most effective thing your business can do to gain more repeat business, more referral work, and competitor differentiation. Companies like Xometry, ProtoLabs and 3D Hubs have already figured out how to sell to the new generation of part buyers. We'll show you some simple steps you can take to improve your customer experience and win more work.

Reliability *for miles*



Real reliability isn't promised; it's proven. Virtually every American industry that helps make the world work has trusted Vlier for its design solutions.

Stop by Booth 5526 to see if a Vlier part is the perfect fit for your next project!

Insist on Vlier. Vast Product Selection. Versatile Applications. Superior Value and Performance.



Spring Loaded Devices



Ball Lock Pins



Leveling Devices



Quick Release Plungers



Vlier Products,
a unit of Hutchinson Defense & Mobility Systems
1.800.821.1090 | vlier@vlier.com | vlier.com

ISO:9001 Certified
AS9100 Certified
Cage Code: 01226

A Deep Dive in to Metal 3D Printing

TUESDAY, MAY 14 | 11:20 AM - 12:00 PM

THURSDAY, MAY 16 | 11:20 AM - 12:00 PM

George Morar, Applications Engineer, Protolabs

Sponsored by:  **PROTOLABS**

Direct metal laser sintering (DMLS) is an emerging additive manufacturing technology that has great potential to change the way metal parts are manufactured. DMLS is ideal when trying to achieve complex geometries, lightweight metal parts, or reduced components. This presentation compares flawed versus optimized geometry, discusses part design considerations, and explores secondary operation options to keep in mind when designing for DMLS.

How to Reduce Sheet Metal Design Risks and Production Costs

WEDNESDAY, MAY 15 | 2:20 - 3:00 PM

Jamie White: Product Manager, Sheet Metal Fabrication, Protolabs

Sponsored by:  **PROTOLABS**

You're bound to encounter a few twists and turns when designing parts for sheet metal fabrication. In this presentation, we'll briefly look at the multi-step manufacturing process involved in creating sheet metal parts and the various equipment used along the way. You'll learn which part features increase production risks, the resulting design implications, and most importantly, how to reduce that risk through design iterations. We'll also discuss tactics to reduce overall production costs.

Making Shop Workflow Accessible and Easy to Digest

TUESDAY, MAY 14 | 3:20 - 4:00 PM

Vahid Kalhori, Director, Business Innovation, Sandvik Applied Manufacturing Technologies

Sponsored by:  **SANDVIK**

Smart Manufacturing, Industry 4.0, the Digital Thread, Big Data, they're all related—and all the buzz—but what's it all even mean? How does the jargon apply to a real shop? The truth is, there's plenty that can be done without putting RFID chips and sensors on every piece of equipment. By simply organizing basic data already onsite shops can learn from the past and help to predict

and improve the future without having to reinvent the business or hold a meeting every time there's a decision to be made.

By making shop workflow accessible and easy to digest, whether it's via mobile devices or even a whiteboard, it's not only making it easier for the teams to communicate with each other, but also help to recognize opportunities for efficiency and keep the operation churning along without much disruption. This presentation discusses how to significantly remove room for error and save time all at once by data transparency.

Preparing for the Loss of Your Go-To Guy - Make Your Know-How Digital to Stay Competitive and Always be Prepared for Change

WEDNESDAY, MAY 15 | 10:20 AM - 11:00 AM

Jenny Hörnlund, Director, Digital Sales and Marketing, Sandvik Applied Manufacturing Technologies

Sponsored by:  **SANDVIK**

Small to medium machining shops know all too well the importance of experienced machinists and programmers. Their unique knowledge of your tools, machinery and their controls—not to mention the floor as a whole—is invaluable. Add a high-mix, low-volume workflow to the equation and there's no substitute for his ability to adapt, set up tools and machines and program on the fly.

In addition, experts on business operations of any kind will tell you clear and repeatable processes are a foundation of success. They stabilize the day to day and build a barrier between efficiency and inefficiency. One way they do this is by making it easier for different people to step in and get different things done, something that will be crucial as you prepare new leaders for the shop floor.

You might call programming the center of the shop wheel: tooling and machinery, quoting and cutting, programming impacts the hardware, software and processes throughout the business. It's why we think improving and simplifying the process can have a huge impact on a shop's ability to be resilient in the face of key personnel departures and get more 3-axis work done. It's a big reason we developed Prism for CNC programming.

**In the aerospace industry, only a few
CNC controllers can help you reach the
skies...**

**But can they also help you
reach the stars?**

On August 12th, 2018, the Parker Solar Probe was launched to the Sun. The extremely high precision heat shields were produced by machines equipped with **Fagor 8065 CNCs**.

eastec

May 14th-16th

Come visit us in Booth 2123



FAGOR AUTOMATION

Open
to your
world

fagorautomation.us

Chicago | Dallas | Florida | Los Angeles | Montreal | Atlanta | Toronto

For more information:

800-4A-FAGOR or

info@fagor-automation.com



HUMANITY
AT WORK

MONDRAGON

CNC Systems | Digital Servo Motors & Drives | Feedback Systems | DRO Systems | Motion Control Systems

Industry 4.0 Simplified for All - Job Shop to OEM - Quoting to Quality

THURSDAY, MAY 16 | 12:20 - 1:00 PM

Gregg Bigleman, PhD

Sponsored by: 

A conversation on how we got to where we are and to what we need to do to fix a broken trend in our industry. Past, present, and what to do now. Also, what to avoid on your path to implementing I4.0

What will be gained by attending?

- An understanding on how we got here
- A solution for a broken concept
- Warning of false profits

What will be discussed or shared?

- Industry 4.0 for Job Shops to OEMs.
- Introduction of a solution - Digital Manufacturing Loop
- Innovative products throughout the Digital Manufacturing Loop
- Quoting to Quality

The Industrialization of Metal Additive Manufacturing; Some Days Are Diamonds; Some Days Are Rocks

TUESDAY, MAY 14 | 2:20 - 3:00 PM

WEDNESDAY, MAY 15 | 11:20 AM - 12:00 PM

THURSDAY, MAY 16 | 9:20 - 10:00 AM

Graham F. Boyd, Regional Manager - Northeast, SLM Solutions

Sponsored by: 

Metal additive manufacturing production and design has ushered in a new era in design, engineering and manufacturing where complexity comes free and barriers to entry that were once unattainable are now available. In well regulated industries like aerospace, medical and automotive balancing this paradigm shift in thinking with the quality standards developed over years of experience brings challenge. In this session we'll identify key challenges to wide adoption and how the industry can better foster this new era of industrialization.

KNOWLEDGE BAR

The Knowledge Bar is located in the SME Zone, Building 1 #1164

Tuesday, May 14 | 10:00 - 10:15 AM

AUTOMATING PART GAUGING FOR HIGH-MIX, SMALL BATCH MANUFACTURING

David Henderson, CEO and Founder, New Scale Robotics

11:00 - 11:15 AM

DEBURRING CROSS HOLES EFFICIENTLY WITH ECM

Mike Hively, ECM Specialist, EMAG LLC

2:00 - 2:15 PM

BENEFITS OF ENGINEERED SURFACE FINISHES

Sanjai Keshavan, Manager, Eco Hone and Microfinish Systems Division, Nagel Precision, Inc.

3:00 - 3:15 PM

MILLING STRATEGIES FOR CHALLENGING AEROSPACE PARTS

Evan Duncanson, Milling Application Specialist, Emuge Corp.

Wednesday, May 15 | 10:00 - 10:15 AM

UNDERSTANDING WELDING PROCEDURE QUALIFICATIONS

Burt Riendeau, Advanced Fabrication Specialist, Airgas USA, LLC

11:00 - 11:15 AM

TRADITIONAL VERSUS MODERN ERP PLATFORMS

Christopher Shadbolt, Senior Sales Executive, Genius ERP

2:00 - 2:15 PM

ALLOY DEVELOPMENT FOR ADDITIVE MANUFACTURING

Aaron LaLonde, PhD, Director of Applications Engineering, SLM Solutions

3:00 - 3:15 PM

REDUCING ELECTRODE WEAR IN AEROSPACE & MOLDING INDUSTRIES

Jim Weirido, Sinker EDM - Applications, MC Machinery Systems/Mitsubishi EDM

SPECIAL PROGRAMS & ACTIVITIES

Thursday, May 16 | 10:00 - 10:15 AM

SOLVING QC BOTTLENECKS VIA WALK-UP METROLOGY

Rick Lasure, Metrology & Precision Sales Manager,
The L.S. Starrett Company

11:00 - 11:15 AM

WHY VACUUM HEAT TREATING?

Tim Steber, Regional Sales Manager, Solar Atmospheres

2:00 - 2:15 PM

ERROR-PROOFING THE TOOL LOAD PROCESS WITH RFID TOOL IDENTIFICATION

Mike Laurendeau, Eastern Regional Sales Manager,
Caron Engineering, Inc.

AUGMENTED REALITY EXPERIENCE

Tuesday, May 14 | 9:00 AM - 5:00 PM

Wednesday, May 15 | 9:00 AM - 5:00 PM

Thursday, May 16 | 9:00 AM - 3:00 PM

The Augmented Reality Experience is located in Building 5, #5258

Sponsored by:  **MAKINO**

Don't miss the Makino Augmented Reality Experience where you can experience the future of machine tool technology like never before. Makino will showcase digital technologies and next-generation innovations using high-tech reality tools that bring the future to life.

NEW ENGLAND MANUFACTURING RECEPTION

Tuesday, May 14 | 5:00 - 6:30 PM

Located in the tented area between Buildings 3 and 5

Sponsored by:  **Mastercam**

As a thank you for your EASTEC participation, please join us for an hors d'oeuvres and cocktail reception on Tuesday, May 14, sponsored by the Eastern States Exposition and Mastercam. This complimentary reception will take place in the tented area between Buildings 3 and 5. Relax and network with fellow attendees and exhibitors while celebrating manufacturing in New England. We hope to see you all there!

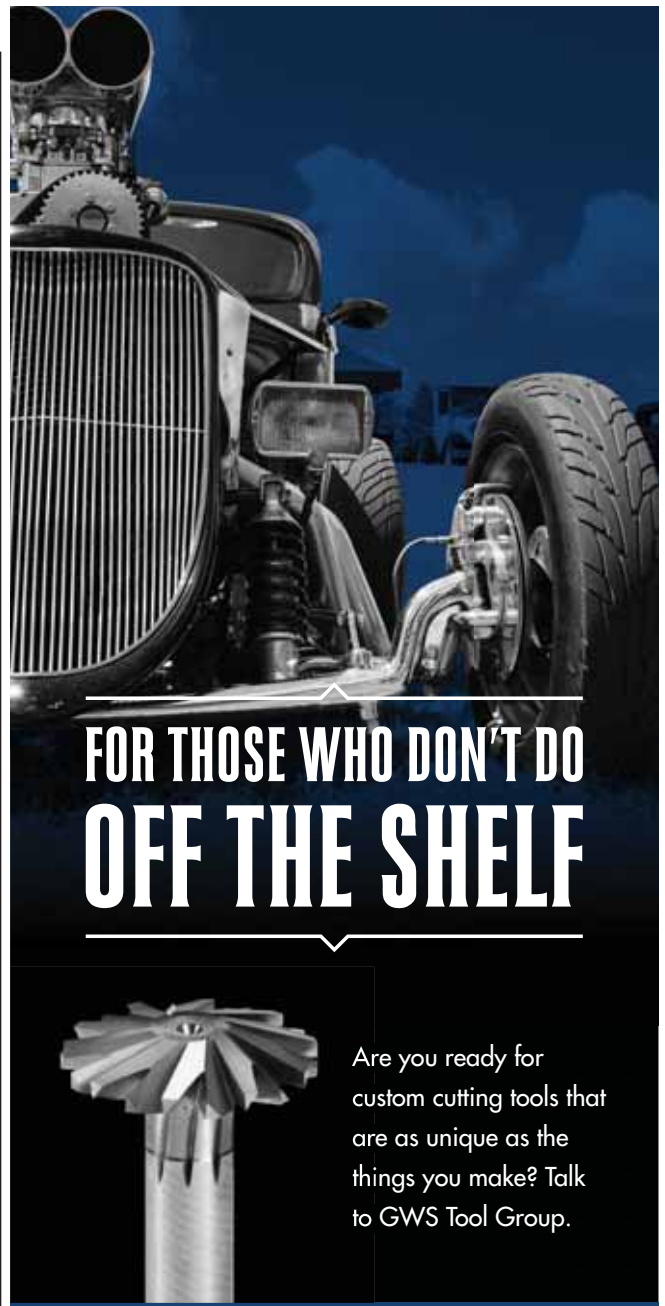

FOR THOSE WHO DON'T DO OFF THE SHELF

Are you ready for custom cutting tools that are as unique as the things you make? Talk to GWS Tool Group.

GWS
TOOL GROUP

CUSTOM COMES STANDARD
GWSTOOLGROUP.COM

eastec[®]

BOOTH 5621

SME STUDENT SUMMIT

Thursday, May 16 | 8:30 AM - 2:00 PM

The Student Summit is located in Building 4

The Student Summit aims to create interest, excitement and an appreciation for manufacturing, as well as to build awareness with students and educators about manufacturing career pathways. The EASTEC Student Summit allows students to explore exhibits of advanced technologies, talk with industry experts, see the latest manufacturing innovations, and meet local college and university representatives. Students will also have a chance to design and fly Unmanned Aerial Vehicles (Drones) with the help of Ten80 Education.

OBJECTIVES

- Introduce students to the manufacturing industry as a prospective career pursuit
- Provide a high-level overview of advanced design and manufacturing technologies, materials, processes and applications
- Allow students to learn about how and why the technology is used, along with examples of interesting applications
- Provide students the opportunity to ask questions and interact with an industry mentor and see the technology firsthand on the EASTEC show floor

STUDENT BENEFITS

- Gain hands-on experience with product development models and the processes for making physical prototypes
- Obtain a basic understanding of the industry and career options
- Discover a different view of manufacturing
- Become excited to see additive manufacturing as an option
- Understand what engineers can do

BENEFITS TO EDUCATORS AND MENTORS

- Impact the future of the technology
- Influence future workforce
- Demonstrate industry knowledge and leadership

SME PRESIDENT'S RECEPTION

Wednesday, May 15 | 5:00 - 7:00 PM

The SME President's Reception will take place in the SME ZONE, Building 1 #1164

Please join us in the SME ZONE for the SME President's Reception. Meet SME's 2019 President, Mark Michalski, network and collaborate with exhibitors, speakers and other attendees. Enjoy drinks and hors d'oeuvres while connecting with colleagues, friends and business partners. All EASTEC attendees and exhibitors are welcome to attend.

SME CHAPTER ROUNDTABLE LUNCH AND LEARN

Wednesday, May 15 | 11:30 AM - 2:30 PM

Meet with SME's New England and Mid-Atlantic professional and student chapter leaders as well as other SME members interested in attending. This collaborative roundtable will include industry and chapter leader presentations. Be prepared to discuss chapter missions, engagement, recruitment, retention and student chapter relationships. A networking session will conclude the roundtable conference.

ROUNDTABLE SCHEDULE

- 12:00 PM** Special Member Luncheon
- 12:30 - 1:30 PM** Roundtable Conference

Meet at the SME Show office inside the entrance to Building 5

APPRENTICESHIPS IN MASSACHUSETTS: RESOURCE SUPPORT FOR MANUFACTURERS

Thursday, May 16 | 10:45 - 11:45 AM

Takes place in Storrowton Tavern, Massachusetts Room

Leslie Parady, Workforce Development Manager, MassMEP



What do a CNC machine operator, a robotics technician, and a technical sales person all have in common? They are all jobs that can be learned through an apprenticeship. While 75 years ago the apprenticeship system started in construction and other skilled trades, today there are apprenticeships in over 1,000 occupations - including emerging careers in Advanced Manufacturing.

Your partner for innovative manufacturing

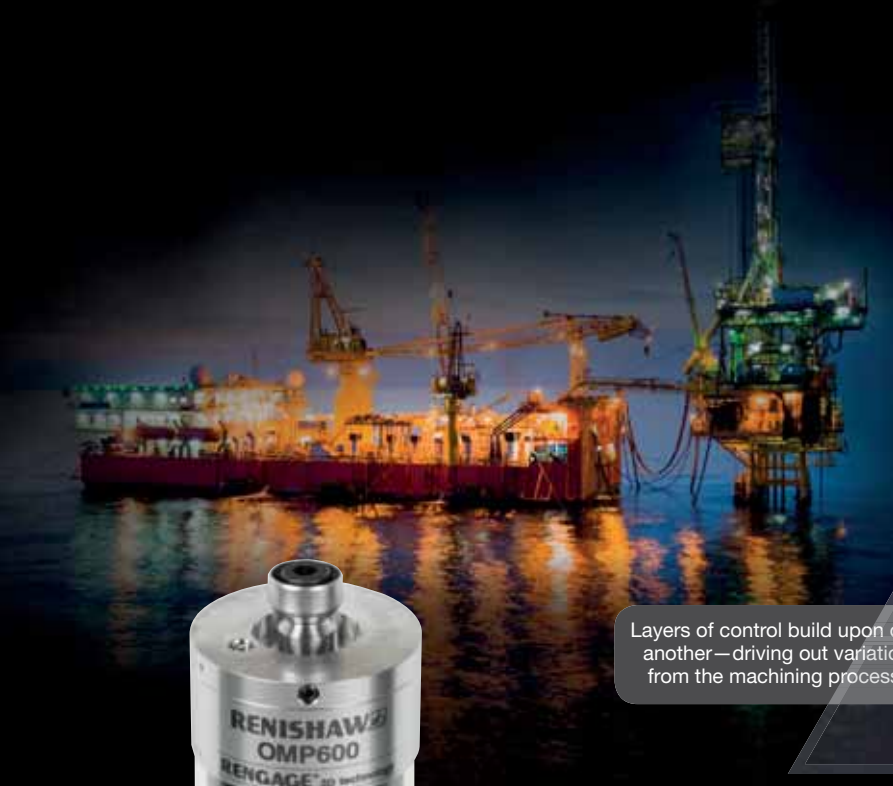

Layers of control build upon one another—driving out variation from the machining process.

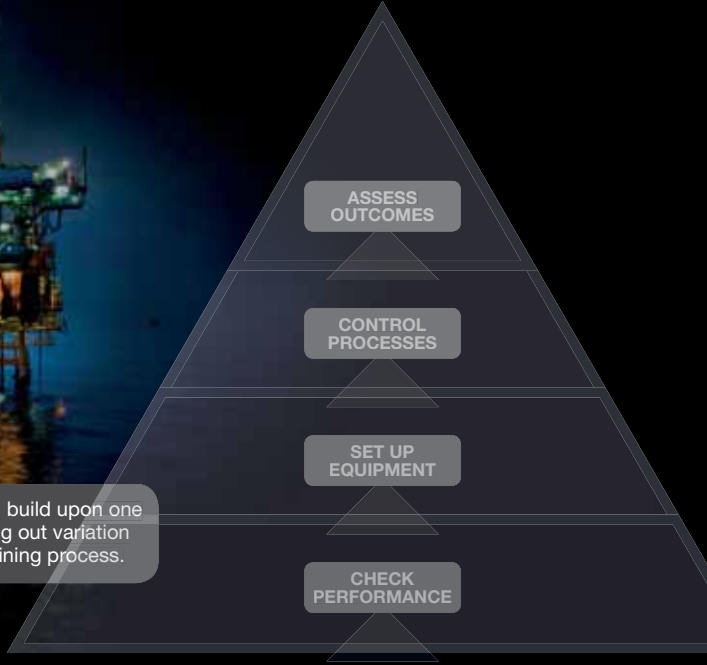

OMP600
High performance machine tool probe for workpiece inspection, job set-up, in-cycle gauging and increased confidence in unattended machining.

As manufacturers ourselves, we understand the challenges you face. For 45 years, Renishaw has been creating breakthrough innovations that solve manufacturing problems and increase productivity across the entire energy sector. Our suite of advanced solutions allows manufacturers to work to ever-tighter tolerances and significantly improve throughput. From additive manufacturing to post-process control, our proven technologies are found at the forefront of intelligent production systems.

Allow us to show you how the integration of innovative manufacturing techniques improve overall productivity and how we can be your partner for innovative manufacturing.

www.renishaw.com/energy

See us at **eastec**
BOOTH #3151





Henry Babiec

*Manufacturing Applications Engineer
Connecticut Center for Advanced
Technology (CCAT)*

Henry has over twenty years of extensive manufacturing engineering experience in a range of industries and has been leading CCAT's Hybrid Manufacturing Program for the past two years.



Denise Ball

*Workforce Development Specialist
Tooling U-SME*

Denise Ball is a Workforce Development Specialist for Tooling U-SME, an industry leader in manufacturing workforce education and development. She has served as a practitioner of best-in-class learning and development techniques for the manufacturing industry for over 25 years. Her extensive background includes workforce development for customized training at Lakeland Community College in Ohio. She also brings hands-on experience in manufacturing as she assisted her family in running a small machine shop for several years. For the past 7 years, she has guided the implementation of workforce education and skills training into corporations across the globe to help develop their workforce with success, as well as facilitated workshops on best practices and various webinars. She resides in Ohio with her husband and has 5 children.



Alan Beaulieu

*President and Principal
ITR Economics*

One of the country's most informed economists, Dr. Alan Beaulieu is President and a principal of ITR Economics. Since 1990, he has consulted across North America, Europe, and Asia, optimizing companies' forecasts and planning to increase profits through his mastery of business-cycle trend analysis. Alan also serves as Senior Economic Advisor to numerous US and international trade associations.

Alan has coauthored, with Brian Beaulieu, the books "Make Your Move," "Prosperity in the Age of Decline," and "But I Want It!" He has also penned numerous articles and makes up to 90 appearances a year. Alan's keynotes and seminars have helped thousands of business owners and executives capitalize on emerging trends.



Corey Carolla

*Vice President Corporate Development
Red Rabbit Automation*

Corey Carolla is VP, Corporate Development with Red Rabbit Automation. His role is to create Automation & Integration solutions to successfully take companies into the next Industry revolution. Corey has helped develop and implement business, economic development alliance collaborations to support and advance the economic vitality of the Midwest.

Bar Feeding. It's What We Do.

Edge Technologies Offers Economical Excellence, Superior Design, and The Heaviest Built Bar Feeders, All Backed by a Team Second To None. What's Not To Love?



FMB Turbo 2-20



FMB Minimag 20



FMB Turbo 3-38



FMB Turbo 5-65

**HEAVY
METAL**

eastec

VISIT US IN BOOTH# 1348

Edge Technologies is a leading productivity solutions provider to the precision metal working industry. We offer the full lines of FMB and Edge bar feeders for Swiss Turning and Fixed Headstock lathes.

Edge Technologies is made up of a group of dedicated professionals, a team with nearly 25 years of experience, who stand ready to pounce on any problem and resolve it immediately.

The Edge line of "Economical Excellence" magazine bar feeders and short loaders are the new industry standard for quality at affordable prices. The new Scout 320 is the newest and most economically priced Edge brand magazine bar feeder in the line. If you are considering an economical 12' magazine barfeeder, you should discuss this product with your Edge Technologies Regional Sales Manager or your local dealer before you buy any brand.

FMB magazine bar feeders are smartly designed, robust in construction, built in Germany to the highest quality specifications, and all of them are a bit on the hefty side. As a matter of fact, some of them outweigh the competition as much as two to one. That's "Heavy Metal."

Visit us at EASTEC 2019 in Booth 1348 and get more information on how your Productivity Partner can help your bottom line.



Edge Rebel 80 Servo



Edge V-65 Servo



Edge Minuteman 320 SE



Edge Patriot 338

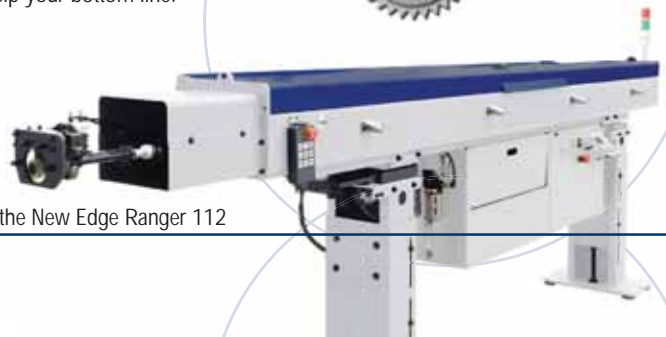

See the New Edge Ranger 112

Visit Us During EASTEC:
Booth #1348
Building 1

EDGE TECHNOLOGIES

call or click: 314.692.8388
www.edgetechnologies.com



Chris Ciunci

Managing Partner

TribalVision

Chris Ciunci is the Founder and Managing Partner of TribalVision, an outsourced marketing department for hire in Massachusetts and Rhode Island. Chris oversees TribalVision's strategy, marketing and thought leadership initiatives. In addition, Chris and his team develop comprehensive marketing strategies for manufacturers looking to achieve dramatic top-line growth.



Jeffrey Crandall

Additive Manufacturing Research & Applications Senior Engineer

Connecticut Center for Advanced Technology (CCAT)

Jeff is the Additive Manufacturing Research and Applications Senior Engineer for Connecticut Center for Advanced Technology (CCAT) in East Hartford, CT, and is directly responsible for leading projects involving metals additive applications and development, and technology demonstration and validation programs for wide range of customers.



David Dussault

CEO

P1 Holdings, Inc.

David Dussault - CEO, P1 Holdings, Inc. David is the founder and CEO of DHA Holdings, Inc. (DHA), a high-tech investment company that builds global businesses in the manufacturing and technology sectors with a focus on industrial markets. DHA is hands-on; building new businesses and expanding market share with an active role in daily operations. His responsibilities span all aspects of strategic planning, operations and brand; including organizational design and implementation, business development, value management, financial planning and investment strategies, team formation in addition to operational oversight and quality systems. As founder of DHA and its portfolio companies, David has successfully designed and managed multiple company lifecycles from start-up to growth and maturity for 4+ businesses over the last eight years. His strengths include active strategic initiatives, operational design and deployment in addition to team formation.



Eric Fogg

Co-Founder and COO

MachineMetrics

Eric Fogg is the Co-Founder and Chief Evangelist at MachineMetrics. Eric is a serial entrepreneur, and life-long manufacturing industry expert holding multiple manufacturing patents. Eric is responsible for product strategy, customer integration, and hardware development.



Marty Guay

*Vice President, Business Development
Stanley Black & Decker*

Marty Guay is the Vice President, Business Development, for Stanley Black & Decker. In this capacity, Marty looks to create value creation opportunities by working with startups, innovation eco-systems, and the entrepreneurial community.

Previously, Marty was the President of STANLEY Healthcare, a global business and operating division of Stanley Black & Decker, a Fortune 500 company with a track record of innovation and sustained profitable growth. STANLEY Healthcare is a recognized leader in solutions that transform safety, security and operational efficiency for senior living organizations, hospitals and health systems.

Prior to STANLEY Healthcare, Marty was a senior leader at STANLEY Security, the second largest global provider of electronic security. He served as the President, Integrated Systems as well as the Vice President of Sales and Operations for North America. Before joining STANLEY, Marty had twenty years of security experience notably as the President of Niscayah, USA and the Chief Operating Officer for Securitas Systems.

Marty is an executive member of The Center for Patient Safety Research and Practice based at the Brigham & Women's Hospital and Harvard Medical School. He is also a Board Member of Massachusetts Advocates for Children, a non-profit organization that removes barriers to educational and life opportunities for children and youth.

Marty earned a Bachelor's degree and M.B.A. from the George Washington University. He completed the Program on Negotiation at Harvard Law School.



Eric Kam

*Solution Market Strategist Smart Factory
ESI Group*

Eric Kam is the Smart Factory Solution Strategist with ESI Group. He supports Extended Reality solutions for Product Engineering/Integration, Virtual Build & Maintenance. A digital transformation advocate, he seeks to democratize simulation technologies in CAE, FEA, and CAD. Longtime member-leader of SME technical communities, with a BSME from Michigan Tech.



Michael Munday

*CEO and Owner
Arwood Machine Corporation*

Arwood Machine Corporation is a precision manufacturing company in Newburyport, MA. President since 2007, Munday previously held executive positions at Magellan Aerospace, Palmer Manufacturing and Textron. Prior to that he served in the US Army, 82nd Airborne division. A strong advocate of workforce development and training, he has served on Commonwealth Corporation's Board of Directors and the Planning Board for the Merrimack Valley Workforce Investment Board, the Whittier Regional Vocational Technical High School and Greater Lawrence Technical School. In 2013 he won Pioneer Institute's Better Government competition for a white paper titled "Manufacturing Revitalization."



Frank Nuqui

*Aerospace Program Manager
FANUC America*

Frank Nuqui has been involved in complex manufacturing for 10+ years with roles ranging from service to aerospace program manager. Frank's experience includes 5 axis machining processes and automation.

**Mary Ann Pacelli***National Program Manager**Manufacturing Extension Partnership (MEP)*

Mary Ann Pacelli is the National Program Manager, Workforce Development at the Manufacturing Extension Partnership (MEP), a division of NIST in the US Department of Commerce. Her work includes advocating for Manufacturing Workforce priorities with related federal agencies and providing technical support to the network of MEP centers across the country for workforce related activities. Mary Ann's roles at NIST and the NIST MEP also include supporting the Manufacturing USA Institute Network with the NIST Program Office and facilitating the coordination of the Education and Workforce Development Directors of the 14 Institutes. Previously she was Assistant Director, Workforce and Talent Development at MAGNET (Manufacturing Advocacy and Growth Network), an Ohio MEP affiliate center. Ms. Pacelli coordinated efforts for new business development and the delivery of training and consulting services to area manufacturers designed to improve performance of the organization. In addition, she directed activities to access federal, regional and local funding for projects related to developing a stronger manufacturing workforce pipeline in Ohio.

Ms. Pacelli's experience in Workforce Development began working for Cuyahoga Community College's Corporate Services Division, and the Council for Adult and Experiential Learning (CAEL), a Chicago based education and training firm. For over 28 years, Ms. Pacelli has served numerous manufacturing businesses by assessing their needs and designing and delivering customized programs to improve employee performance.

Ms. Pacelli has a BS/BA in marketing from John Carroll University and a Master's in Education in Adult Learning and Development from Cleveland State University.

**Rick Schultz***Aerospace Program Manager**FANUC America*

Rick Schultz has been involved in advanced manufacturing processes for more than 25 years in many different capacities. His current role is focused on advanced aerospace manufacturing conceptualizing flexible automation solutions and optimal part manufacturing processes.

**Pete Winiarski***CEO & Founder**Win Enterprises, LLC*

Pete Winiarski is the CEO of Win Enterprises, LLC, and the creator of the Win Holistic Transformation Model™ and of CompleteBusinessTransformation.com. Pete is a globally recognized transformational leader, an international best-selling author, and a frequent business expert in the media. Pete has held leadership positions at the Wiremold Company, Danaher, McKinsey and Company, and the George Group.

**Shane Yount***President**Competitive Solutions, Inc.*

Shane Yount is a nationally recognized author, speaker and President of Competitive Solutions, Inc., an international Business Transformation consulting firm which pioneered the acclaimed organizational development system known as Process Based Leadership®. He has worked with Michelin, Glaxo Smith Kline, Pfizer, Lockheed Martin, the Department of Defense and many others.

SIEMENS

Ingenuity for life

Be smarter
and more
flexible—
see how.

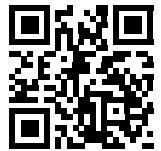

“With Siemens,
I control my future.”

As a machine shop owner, I want to be smarter and more flexible in my manufacturing; I want to be more competitive. So when I invested in my CNC machine, I insisted on the control system that delivers the greatest returns.

By choosing SINUMERIK CNC, I now have a greater return on my machines, my operations and my people.

Visit us at EASTEC booth 2012 to learn more.

usa.siemens.com/cnc4you

Exhibitor

Booth

3D Systems	5241	Alpha Additive Manufacturing Technologies	5615	Blast & Wash Systems	5509
4D Technology Corp	3211	Alpha Grainger Manufacturing	5683	Blue Photon Technology & Workholding Systems LLC	5734
A. TEC Diamond Co Ltd	5006	Alpha Laser - US	2105	Bodycote Thermal Processing	2031
ABTech Inc	3012	Alpine Bearing Co	5669	Bonal Technologies Inc	1136
Access Manufacturing Systems	5452	Amada Marvel Inc	2114	Boston Laser Tech	5722
Accurate Metal Finishing LLC	5829	Amada Miyachi America	2101	Boston Tooling & Machining Association Inc	5245
Accurex Measurement Inc	3139	Ambrell Induction Heating Solutions	2008	Boyum Solutions	5868
Acer Group	1705	American Systems & Equipment Corp	1022	Branson Ultrasonics Corp	3235
ACM Technologies	3124	ANCA Inc	1244	Bristol Tape Corporation	5851
Acorn Industrial Products Co	5415	Anoplate Corp	5726	Brook Anco Corporation	2110
ACSYS Lasertechnik US Inc	1028	Applied Air Systems	324	Brooks Assoc Inc	1206
Action Bearing Co	5514	Aquajet Cutting Technology	1654	Bruker Corporation	3026
Admiral Metals	5516	Aquest Corp	3347	Brush Research Manufacturing Co	5608
Advance Welding	5870	ARCH Cutting Tools & Beamer Laser Marking Systems	5666	Buffoli North America	2041
Advanced Coating Service	5624	Armology of Connecticut Inc	5246	Burr King Manufacturing Co	1713
Advanced Machine & Engineering	5843	Arnold Supply Inc	5548	Butler Bros	5637
AER Control Systems LLC	5762	American Society of Mechanical Engineers	5751	BUWW Coverings Inc	3335
Aerodynamics Inc	5482	ATAGO USA Inc	5745	C2G	3020
Aerospace Alloys Inc	5729	Atrump Machinery Inc	1762	CAD BLU Inc	5840
Aimtek Inc	2108	Autodesk Inc	5326	Cambridge Vacuum Engineering	5857
Air Filtration Systems	3059	AutoForm Engineering USA Inc	5467	Capture 3D Inc	3044
Air Inc	3039	AUTOMATIC LUBE SYSTEMS INC	5869	Carbide Grinding Co Inc	5341
Air Turbine Tools	5753	Automation Engineering Co	5759	Carlson Fabrication Solutions	2128
Airflow Systems Inc	3309	Axis New England	3328	Carmex Precision Tools LLC	5016
Airgas	1656	Babin Machine Tool	1743	Caron Engineering Inc	5432
Airline Hydraulics Corp	1820	Behringer Saws Inc	2000	Carr Lane Manufacturing/ Carr Lane Roemheld	5659
AirLoc Corp	5769	Belmont Equipment & Technologies	1248	CEIA USA Induction Heating Systems	1243
Ajax Tocco Magnethermic Corp	1026	BENZ Incorporated	5544	Centaur Precision Tools Inc	5512
AKS Cutting Systems Inc	1846	Big Kaiser Precision Tooling Inc	5248	CERATIZIT USA Inc	5263
Alexandria Metal Finishers	5742	BlackHawk / Kennametal	5563	CGTech	5350
Alliance For American Manufacturing	3229	Blaser Swissslube Inc	5648	Chambrelian SAS	2130
Amada Machine Tools America	1754				
Allied Machine & Engineering	5453				
Aloris Tool Technology Co Inc	5332				

Chapin & Bangs Steel Co/ Lindquist Steels Inc	5012
Chemetall US Inc	3234
Chicago Pneumatic Tool Company LLC	5824
Chumpower Machinery Corp	5770
CIMCO Americas LLC	5716
CIMCOOL Fluid Technology	5823
Cimquest Inc	5036
Cincinnati Inc	1844
City of Bristol CT	5871
Clamptek USA Inc	5684
Cleaning Technologies Group	3219
CMS North America Inc	1842
CNC Systems Inc	1328
Comco Inc	5545
Conley Casting Supply Corp	5739
Contour360	5559
Control Gaging Inc	3224
Controx Inc	5571
Cool Grind Technologies	1745
Cosen Saws	2142
CPU Automation Inc	3145
Crest Ultrasonics Corp	3058
Cubic Machinery Inc	1021
Curbell Plastics Inc	5771
Current EDM Inc	1255
Custom Service Solutions Inc	3218
Cutler Industrial Sales	5469
Cutting Tool Engineering Magazine	3315
Da/Pro Rubber Inc	340
Dapra Marking Systems	2037
Darex LLC	5676
Datron Dynamics Inc	5240
DCM Tech Inc	1125

Decade Products Inc

3317

DeCosmo Industrial Auctions &
Thomas Industrial Machinery Co Inc 1239

Upgrade to trusted measuring results.

ZEISS SPECTRUM

New!



With the ZEISS SPECTRUM CMM you enter a new level of precision and trusted results – at an unmatched price-performance ratio.

The combination of ZEISS VAST XXT and ZEISS RDS-C5 including CAA increases the reliability and reduces operation time of measurements enormously. It also enables a wide range of measurement tasks. See the ZEISS SPECTRUM at EASTEC, booth 3159.

Find out more at www.zeiss.com/spectrum



Exhibitor

Booth

Deluxe Systems	3340	Ergo Advantage	5617	Genius ERP	5663
Dennison Lubricants	5662	Ergotronix Inc	5144	Gentiger Machinery Industrial Co. Ltd	1061
Design 2 Part Magazine	5725	Erowa Technology Inc	1628	Gesswein Co	5653
Diacut Inc	3226	ESPRIT/DP Technology Corp	5259	GF Machining Solutions	1420
Digipas Technologies Inc	5340	Eureka Chemical Co	3243	GH Induction Atmospheres LLC	2033
Dillon Chuck Jaws	5537	Euro-Tech Corp	5336	Gibson Engineering Co Inc	3045
Dino-Lite Scopes (BigC)	3143	Everede Tool Company	5649	GKS Lifting and Moving Solutions LLC	3325
DISCUS Software Company	3238	Fabricating & Metalworking Magazine	3321	GMA Garnet	1719
DoALL Sawing Products	2133	Factory Cat	3339	Godex International Americas	5622
Doringer Cold Saws	2035	Fagor Automation Corp	2123	Gradient Lens Corporation	3150
Dorsey Metrology International Inc	3119	FANUC America Corp	1018	Greenleaf Corp	5317
DuBois Chemicals Inc	5449	FARO Technologies Inc	3135	Griffo Brothers Inc	5034
Dynabrade Inc	5677	Fastenal Company	5575	Grobet USA	5520
Dynamic International	1454	Faxon Engineering	1768	GTI Spindle Technology Inc	5562
ECM Global Measurement Solutions	3008	Fimor NA	5363	Guhring Inc	5333
Ebbco Inc	1727	Fischer Technology Inc	5738	GWS Tool Group	5621
ECi Software Solutions	5532	Fisher Unitech LLC	5054	Haas Factory Outlet - Trident	1218
Eclipse Magnetics	3022	Fitz-Rite Products Inc	5645	Haas Multigrind	1051
Ecoclean Inc	3019	Fixtureworks	5766	Haimer USA	5458
Edac Technologies	5553	FlexArm Inc	5541	Halder Inc	5427
Edge Technologies	1348	Flexbar Machine Corp	3157	Hangsterfer's Laboratories Inc	5632
EDM Network Inc	1648	Flow International Corp	1712	Hannsa Precision	1027
EIGHT TOOL America	5647	FOBA Laser Marking + Engraving I Alltec GmbH	3341	Hardinge Inc	5444
Electrodes Inc	1128	Fortune Metal Finishing Corp	5414	Hardline Heat Treating Inc	2011
Elm Electrical	1852	Fowler High Precision Inc	3251	Harvey Industries International Inc	3343
EM Benson Co	5141	Fronius USA LLC	1737	HASCO America Inc.	5010
EMAG LLC	1045	Front Panel Express	5568	Hassay Savage Co	5774
Emuge Corp	5369	Fryer Machine Systems Inc	1720	Hawkeye Innovation LLC	5838
ENCON Evaporators	5421	Fullerton Tool Co	5736	Hayden Corp	5827
Engis Corp	5028	G II Solutions Inc	1253	Heavy Duty Floors	3323
Ensitech Inc	5758	Modern Machine Shop	5746	Heidenhain Corp	1634
Epicor Software Corp	3240	General Manufacturing Inc	1863	Hemel Engineering Products Inc	3207
Epilog Laser Corp	2129	Genevieve Swiss Industries Inc	5133	HEM Inc	2038
Ercolina - CML USA Inc	1753				

EXHIBITORS — QUICK REFERENCE

Hermann Schmidt Co	1723	Johnson Gage Co	3042	LS Industries Inc	3043
HEULE Precision Tools	5385	Toyoda Americas Corporation	1034	Lubrication Technologies Inc	5737
Hexagon Manufacturing Intelligence	3103	Judge Tool & Gage	3138	Lucifer Furnaces Inc	2003
High QA, Inc	341	KAAST Machine Tools Inc	2134	Lyndex-Nikken Inc	5533
Hirschmann Engineering USA Inc	1231	THINBIT	5348	Lynn Welding	2027
Hiwin Corporation	3034	Kalow Technologies	5821	Macdac Engineering	5233
Holts Precision Inc	3156	Kasto Inc	1661	Mach 1 Systems Inc	1725
Holts Precision Inc	5419	Kays Engineering/DeHoff/Eldorado	1612	MachineMetrics	5037
HORN USA Inc	5353	Keller Products Inc	3057	Magido USA	1838
Houghton International Inc	5560	Ketcham & Co Inc	3306	Magnus Precision MFG Inc.	5862
HPM Technologie GmbH	5765	Keyence Corp of America	2042	Makino Inc	1236
Hudson Tool Steel Corporation	5538	Keyence Corp of America	3029	Manufacturing News	5864
Huron Machine Products	5000	Kgk International Corp	1662	MAPAL Inc	5327
Hyd-Mech Group Ltd	2122	Kitagawa-NorthTech Inc.	1152	Marposs Corp	1644
Hygrade Precision Technologies	5566	KMT Waterjet Systems Inc	1344	Martindale Electric Co	5719
igus Inc	5852	Kolver	5619	Marubeni Citizen Cincom	1406
IMS USA LLC	5727	Koma Precision Inc	5359	Mastercam/CNC Software Inc	5249
INIRAM Precision Machine Tool Inc	1468	KSI Swiss	1640	Matterhackers	5848
InnovMetric Software Inc	3244	Kyocera Precision Tools Inc	5573	MAXTOOL CORP.	5002
InspectionXpert Corporation	5865	Kyzen Corporation	3027	MB Metal Technologies LLC	2009
Internal Tool	5853	L.F.O'LEARY CO.INC/GLASTONBURY SOUTHERN GAGE	3254	Mitsubishi EDM / MC Machinery Systems Inc	1426
Ironclad Machinery LLC.	1064	Lamothermic Corp	5614	MCRL Inc / Fluid Chillers	1001
iSwiss Corporation	5616	Lang Technovation Co	5483	Melin Tool Company	5618
item Northeast	1861	Laroche Foundry Ltd	5362	Metallurgical Processing Inc	5724
J & L Metrology Inc	3255	Laser Marking Technologies LLC	2029	MetalMizer	1814
J&S Machine Inc	5820	Laser Measuring Technologies LLC	3122	Methods Machine Tools Inc	2034
Japan Machine Tools Corp	1052	LaserStar Technologies Corp	2100	Metrologic Group Services	3228
JAYCO Cleaning Technologies	5832	Liberty Packaging Co	3227	Metronor Inc	3127
Jergens Inc	5644	LillyWorks Scheduling & ERP Software	5763	Northeast Machinery Sales/FlexCNC	1228
Jet Edge	1770	Lindco Springfield Co	1118	MIDACO Corp	1858
JH Robotics Inc	1462	LINK INDUSTRIES	5826	Mikro Industrial Finishing Co	5440
Jinan Bodor CNC Machine Co Ltd	1146	LK Metrology Inc	3310	Mikron Corp Monroe	5426
JM Performance Products Inc	5422	Lovejoy Tool Co	5242		
JMD Industries Inc	5536				

Exhibitor

Booth

Marksman represented by Millennium Signatures Marking Systems Inc	3305	Northland Tool & Electronics	5828	Plastics International	5366
Millinocket Fabrication & Machine LLC	2126	NSF International Strategic Registrations	2141	Platinum Tooling	5146
Minuteman / Empire Automation Systems	3301	NSK America Corp	5344	Platit US	5058
Mirka / Cafro	1711	NTK Cutting Tools	5564	Pocket NC Company	5008
Mitee-Bite Products LLC	5459	NTMA	1862	Poco Graphite	1227
Mitsubishi Electric Automation Inc	1140	Numberall Stamp & Tool Co	1142	Polyrix Inc	3129
Mitsubishi Materials USA	5468	Nysus Solutions LLC	3259	Pratt & Whitney Measurement Systems Inc	3006
Mitutoyo America Corp	3111	OASIS Inspection Systems	3050	Praxair Distribution Inc.	1606
Modern Industries Inc	5750	Oasis Scientific Inc	320	Precision Coating Company	5638
Modern Tools Inc	1127	OC White CO	3051	Precision Grinding Inc	5720
Modula Inc	1254	Oerlikon Balzers Coating USA Inc	5567	Precision Jig Fixture & Metrology	5831
Monode	5682	OG Bell Co	5767	Precision Laser Technology LLC	3154
Monster Tool Co Inc	5411	Okamoto Corp	1044	Precision Punch Corp	5633
MP Systems	5368	Olympus America Inc	1766	Preco Inc	5237
MULTICAM EAST	1035	OMAX Corp	1106	Pro Ultrasonics	3055
Nagel Precision Inc	5850	Omega TMM Inc.	5127	Production Metals	1870
NESSteel Inc	5033	Omni Services	5612	ProShop ERP	584
New England Metal Finishing & Precision Finishing Services	5136	OPEN MIND Technologies USA Inc	5228	Proto Labs Inc	5752
New England Miniature Ball	5364	Optinova Americas Inc.	5772	Purex Inc	2102
New England Sales Inc	2026	Origin Technologies Corp	1854	QAD Inc	1869
New Scale Robotics	2139	Osaap America	1132	Quality Plus Inc	3241
Nexas America LLC	5527	OSG USA INC	5652	Quality Vision International	3003
Nexgen Tooling	5747	Packard Machinery Co Inc	1742	Quantum Machinery Group	5671
Nikon Metrology Inc	3203	Paletti USA	3239	R & D Technologies	5776
NITCO Industrial Cleaning Equipment & Commercial Products	3002	Atlas Copco Tools/Palmac	1134	R&R Fixtures LLC	3318
Noble Industrial Furnace	3354	Paperless Parts	5667	Racer Machinery International Inc	1638
Nordfab Ducting	3025	Pauway Corp	5549	Radyne Corp	1102
North Coast Technical	1865	PAWS Workholding	5866	Ram Precision Tool Inc	1626
Northeast Coating Technologies	5540	Pearse-Bertram LLC	3245	Razor Tool	5518
Northfield Precision Instrument Corp	5508	Penn Stainless Products Inc	5043	Realtrac ERP	5721
		Perry Technology Corp	5623	ReCarb LLC	5642
		Peterson Steel Corp	5558	Regal Diamond Products	5547
		Phillips Precision Inc	3342	REGO-FIX Tool Corp	5320
		Pinpoint Laser Systems	3054	Renishaw Inc	3151

EXHIBITORS — QUICK REFERENCE

Rice Machinery Inc	1734	SISMA USA Inc	2104	Tecnomagnete Inc	2145
Rigaku Analytical Devices	3319	SLM Solutions NA Inc	5733	TE-CO	5463
Rittal Corp	5035	SME	1164	Telesis Technologies Inc	2005
RobbJack	5441	Smith & Wesson		The Charles C Lewis Co	5142
Roboris USA LLC	5031	Precision Components	5365	The Custom Group Center For Manufacturing Technology	5582
Rock Ridge Abrasives	5743	SMW Autoblok Corp	2013	The Hope Group	5858
Roemheld	5661	Solar Atmospheres	1251	The Joseph Freedman Co Inc	1772
Rohner	2140	Solidxperts Inc	5670	The Robert E. Morris Company	5464
Rolled Alloys	5232	Somma Tool Co	5542	Thermo Fisher Scientific	339
Rollomatic Inc	1706	Southwick & Meister Inc	5387	Tiertime Corporation	5836
Rosedale Products Inc	3028	SpiderCool	1241	Tool-Flo Manufacturing Inc	5519
Ross Machinery Sales Inc	1620	Sprague Operating Resources LLC	3313	Trak Machine Tools	1434
Ross Solar Group	5641	NCSIMUL Hexagon Manufacturing Intelligence	5358	TribalVision	327
Rotarex Inc NA	5583	Stamptech Inc	5523	TriMech	5137
RUF Briquetting Systems	3023	Star CNC Machine Tool Corp / Eurotech Elite	1444	Tru Tech Systems Inc	1830
Rush Machinery	1129	Starrett Company	3011	TRUMPF Inc	2004
Saacke North America LLC	1156	Starrett Company	5045	Turpin Sales & Marketing Inc	5570
Sanken Industry Co. Ltd.	5749	Stor-Loc Corp	5712	TW Metals	5674
Saturn Industries Inc	1237	Strong Hand Tools	5627	Two Technologies Inc	3326
Sauter North America Inc	5423	Suhner Industrial Products Inc	5020	TYKMA Electrox	3035
Savage Saws	2143	Sumitomo Electric Carbide Inc	5236	Ultimaker	5732
Schlumpf Inc	3056	Sunnen Products Co	2111	Ultraflex Power Technologies Corp	1138
Schunk Inc	5433	Supra Alloys A Div of TITAN Metal Fabricators Inc	5643	UNISIG	1235
Schutte Corp	1056	Surgically Clean Air	5735	United Performance Metals	5728
SciAps Inc	3125	SW North America Inc	1726	Universal Robots USA Inc	1017
Scientific Cutting Tools Inc	5224	Swoosh Technologies	5338	UPC LLC	5849
Seeburger Inc	5844	Syil America Inc	1808	UPS	5833
Service Steel Aerospace Corp	5744	SYNTEC TECHNOLOGY INC	5130	US Shop Tools	5609
ShopFloorConnect	566	Takachiho America Inc.	5741	US Tool Group Inc	5626
Shoptech	5552	Tapeswitch Corporation	336	Vance Metal Fabricators Inc	1824
SIC Marking USA Inc	323	Taylor-Winfield Technologies Inc	2107	Vekttek LLC	5026
Siemens Industry Inc	2012	TCI Precision Metals	5030	Vela Instruments LLC	5842
SIMTEK USA Inc.	5636			Ventilation USA LLC	3018
Sir Meccanica SpA	5445			Vention	329

Waldmann **W**

ENGINEERS OF LIGHT



RAPTOR
SPOT LIGHT



**Shining Light on the Toughest
Industrial Environments**

- Robust aluminum housing
- 3mm solid safety glass
- Gooseneck or pivoting head
- 50,000 hrs maintenance-free

Visit us at **EASTEC** Booth #1614

800.634.0007 · waldmannlighting.com

Verisurf Software Inc	5050
Vision Engineering Inc	3322
VJ Technologies Inc	5835
VKS - Visual Knowledge Share	5370
Vlier Products	5526
Vollmer Of America	1158
Vytek Laser Systems	2022
W & H Stampings & Fineblanking	5550
W T Hight CO	3338
Waldmann Lighting Co	1614
Walker Magnetics	5543
Walrus America Inc	5748
Weima America Inc	335
Wenzel America Ltd	3223
Werth Inc	3213
Wickman Machine Tool Inc	1822
Winslow Engineering Inc	2109
Workplace Modular Systems LLC	5658
WTO USA	5223
WTU Systems LLC	5846
Yamazen Inc	1005
Yarde Metals Inc	2039
YG-1 Tool Co	5474
YMW Taps USA	5522
Yuasa International	1748
ZEISS Industrial Metrology	315
Zimmermann Inc	2137
Zircar Refractory Composites	5822
Zoller Inc	5436

MAY 14-16, 2019

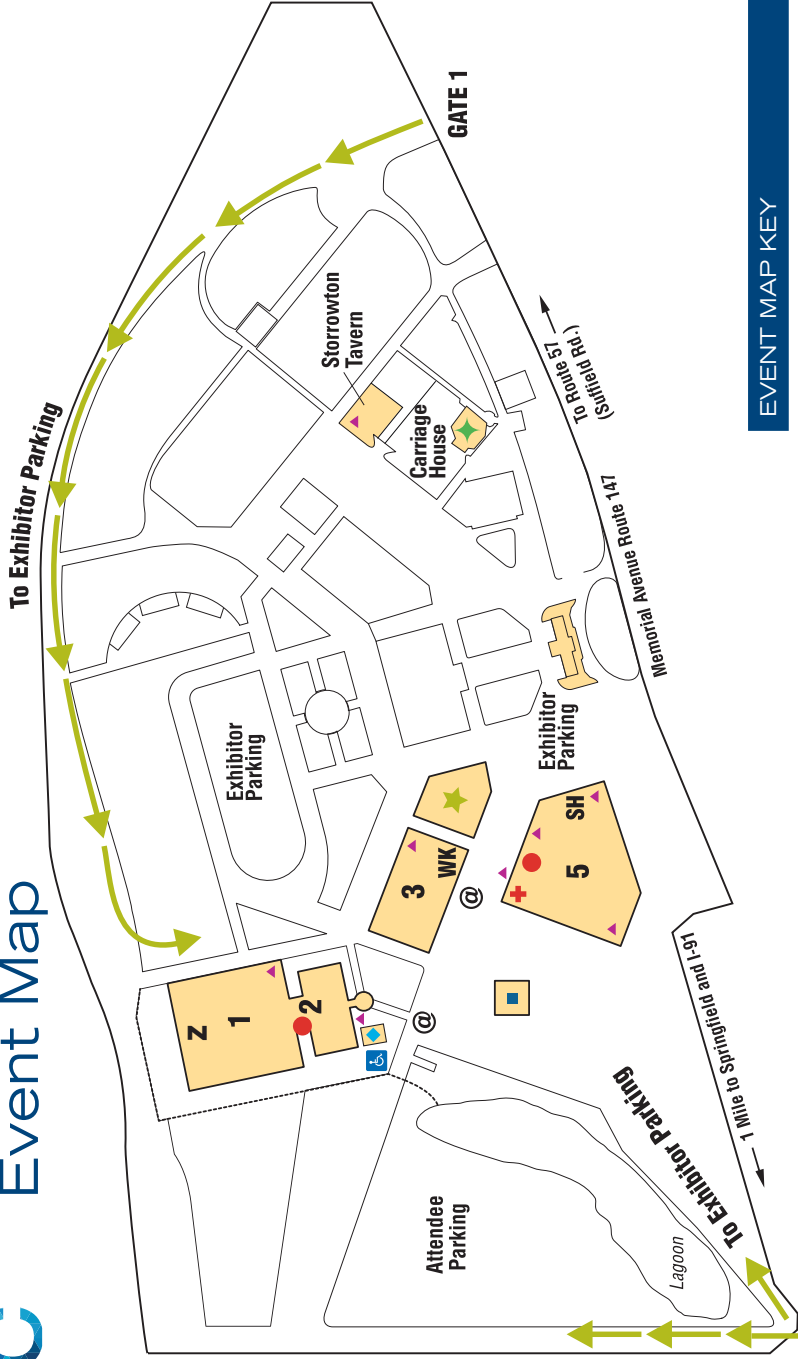

GATE 8 & 9
Attendee & Bldg 5 Exhibitor Parking Entrance

BUILDING & TECHNOLOGY KEY

- Buildings 1 & 2: Mallary Complex**
Exhibits (1000-1999)
→ Precision Manufacturing Equipment & Systems
▲ Food Concessions
- Exhibits (2000-2999)**
→ Precision Manufacturing Equipment & Systems
▲ Food Concessions

- Building 3: Young**
Exhibits (3000-3999)
→ Automation, Quality & Process Improvement
→ Plant, Energy & Environmental Efficiency
◆ Eastec Main Registration
▲ Westside Grill Restaurant
Dunkin Donuts

- Building 5: Better Living Center**
Exhibits (5000-5999)
→ Design, Engineering & Additive Manufacturing/3D Printing
→ Tooling, Workholding & Machining Accessories
▲ Glass House Restaurant, Dunkin Donuts & Food Concessions

EVENT MAP KEY

- 1, 2, Exhibits 3, 5**
◆ Needs to Register, Exhibitor Registration, Lead Retrieval Pick-up
■ Already Registered
★ Student Summit
▲ Food
◆ Additive Manufacturing Seminar
● Show Office & Information Desks
+ First Aid
Z SME ZONE (Keynotes, Lunch & Learns, Complimentary Education, Knowledge Bar, Sales Office, Media Center)
SH Smart Manufacturing Hub
WK Workshops
@ Directional Kiosks
♿ Handicap Parking

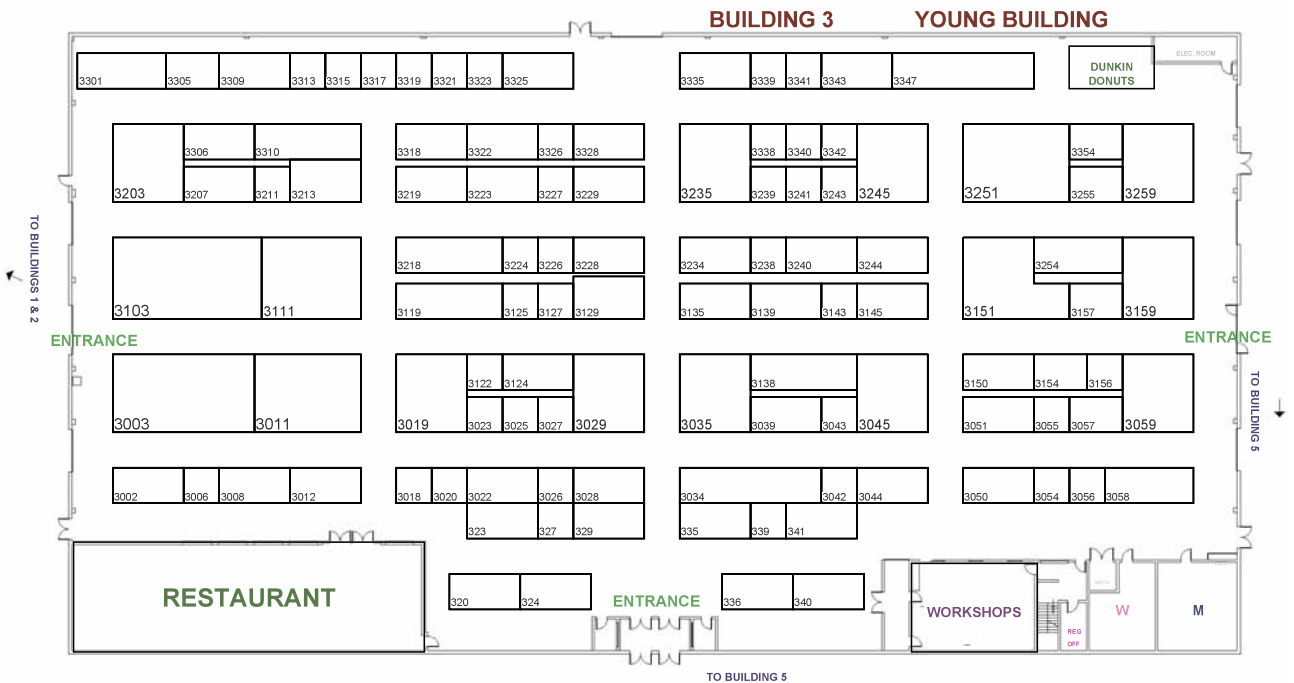



learn. engage. advance.

We are...

Today's thought leaders.

Cutting-edge innovators.

Leading researchers.

The game changers.

sme  | membership

sme.org/join

(As of March 25, 2019)

The following EASTEC exhibitors are featuring new product introductions in their booth.

Exhibitor	Booth				
Access Manufacturing Systems	5452	General Manufacturing Inc	1863	North Coast Technical	1865
Advance Welding	5870	Gentiger Machinery		Northfield Precision	
Advanced Machine & Engineering	5843	Industrial Co. Ltd	1061	Instrument Corp	5508
Aimtek Inc	2108	GF Machining Solutions	1420, 1620	NTK Cutting Tools	5564
Airgas	1656	Guhring Inc	5333	OMAX Corp	1106
Amada Machine Tools America	1754	GWS Tool Group	5621	OPEN MIND Technologies USA Inc	5228
Allied Machine & Engineering	5453	Haimer USA	5458	Phillips Precision Inc	3342
Alpha Laser - US	2105	Halder Inc	5427	Pocket NC Company	5008
Amada Miyachi America	2101	Harvey Industries International Inc	3343	ProShop ERP	5847
ANCA Inc	1244	HASCO America Inc.	5010	QAD Inc	1869
ARCH Cutting Tools	5666	HEULE Precision Tools	5385	Quality Vision International	3003
Atlas Copco Tools/Palpac Co Inc	1134	HPM Technologie Gmbh	5765	R&R Fixtures LLC	3318
AutoForm Engineering USA Inc	5467	Jergens Inc	5644	Rigaku Analytical Devices	3319
Automation Engineering Co	5759	JH Robotics Inc	1462	Sanken Industry Co. Ltd.	5749
Axis New England	3328	KAAST Machine Tools Inc	2134	ShopFloorConnect	5668
BENZ Incorporated	5544	Kolver	5619	Sir Meccanica SpA	5445
Big Kaiser Precision Tooling Inc	5248	Kyocera Precision Tools Inc	5573	SISMA USA Inc	2104
Blue Photon Technology		Lang Technovation Co	5483	SMW Autoblok Corp	2013
& Workholding Systems LLC	5734	Liberty Packaging Co	3227	Starrett Company	3011, 5045
Cambridge Vacuum Engineering	5857	Magido USA	1118, 1838	Strong Hand Tools	5627
Caron Engineering Inc	5432	Makino Inc	1236	Suhner Industrial Products Inc	5020
Chambrelan SAS	2130	Methods Machine Tools Inc	2034	SW North America Inc	1726
Chumpower Machinery Corp	5770	MIDACO Corp	1858	Syil America Inc	1808
Cincinnati Inc	1844	Mikron Corp Monroe	5426	The Hope Group	5858
Clamptek USA Inc	5684	Mitsubishi EDM/MC Machinery		The Robert E Morris Company	5464
Cool Grind Technologies	1745	Systems Inc	1426	THINBIT/Kaiser Tool Co	5348
Crest Ultrasonics Corp	3058	Marksman represented by Millennium		Turpin Sales & Marketing Inc	5570
Curbell Plastics Inc	5771	Signatures Marking Systems Inc	3305	TYKMA ElectroX	3035
Datron Dynamics Inc	5240	Mirka	1711	Vollmer Of America	1158
DoALL Sawing Products	2133	Mitee-Bite Products LLC	5459	Winslow Engineering Inc	2109
Emuge Corp	5369	Mitsubishi Materials USA	5468	Zimmermann Inc	2137
Epicor Software Corp	3240	MP Systems	5368	Zircar Refractory Composites	5822
Fowler Precision Instruments	3251	MULTICAM EAST	1035	Zoller Inc	5436
Fryer Machine Systems Inc	1720	New Scale Robotics	2139		

NTK
CUTTING TOOLS

Milling Cutter for Aluminum Components



Housing Case



Oil Pan



Transmission Case



HFC Cutters

- **Increase in Productivity**
High speeds and feeds with PCD inserts
Light weight aluminum cutter body
- **Tooling Cost Reduction**
More insert pockets than the competition
Insert regrind and re-balance program

Wixom, MI | Toll free: 866-900-9800 | ctinfo@ntktech.com | www.ntkcuttingtools.com

eastec Booth # 5564



HFC video

INTRODUCING



MANUFACTURING TECHNOLOGY SERIES

A NEW APPROACH. ENDLESS OPPORTUNITIES.

Bringing together four strategic regional manufacturing events —
HOUSTEX, EASTEC, SOUTHTEC, and WESTEC — under one umbrella.

Produced By
sme

AMT

houstex®

eastec®

westec®

southtec®

MTSeries.com

The following is an alphabetical list of exhibitors and companies with technologies on display.

3

3D SYSTEMS 5241
333 Three D Systems Circle
Rock Hill South Carolina 29730-7811
803-326-3900
www.3dsystems.com

4

4D TECHNOLOGY CORP 3211
3280 E Hemisphere Loop
Tucson Arizona 85706-5039
520-294-5600 • 520-294-5601
www.4dinspec.com

A

A. TEC DIAMOND CO LTD 5006
64 Sinheung-ro 469 Ojeong-gu
Bucheon-si 421-808
Korea, Republic of
82-10-972-75528 • 82-32-684-1991
www.atecdia.co.kr

ABB 3301
See Minuteman / Empire Automation Systems

ABTECH INC 3012
126 Route 12 North
Fitzwilliam New Hampshire 03447
603-585-7106 • 603-585-7109
www.abtechmfg.com

ACCESS MANUFACTURING SYSTEMS 5452
1 Stiles Rd Ste 205
Salem New Hampshire 03079-2858
603-890-5488 • 603-890-1361
www.accessmfgsys.com

Principals:
CAMWorks
Eureka Machine Simulation
Rize Inc
SolidWorks CAM

ACCURATE METAL FINISHING LLC 5829
414 South St
Randolph Massachusetts 02368-5338
781-963-7300 • 781-986-2134
www accuratemetalfinishing.com

ACCUREX MEASUREMENT INC 3139
225 S Chester Rd Ste 6
Swarthmore Pennsylvania 19081-1919
610-544-1006 • 610-544-1033
www.accurexmeasure.com

ACER GROUP 1705
244 N Randolphville Rd
Piscataway New Jersey 08854-3127
732-752-9100 • 732-752-9101
www.aceronline.net

ACM TECHNOLOGIES 3124
344 Granary Rd Ste A
Forest Hill Maryland 21050-3279
410-420-8001

ACORN INDUSTRIAL PRODUCTS CO 5415
520 Hertzog Blvd
King Of Prussia Pennsylvania 19406-2667
610-636-1187 • 484-322-0910
www.acorncasters.com

ACSYS LASERTECHNIK US INC 1028
8224 Nieman Road
Lenexa Kansas 66214
847-246-2394
www.acsyslaser.com

ACTION BEARING CO 5514
201 Brighton Ave
Boston Massachusetts 02134-2081
800-225-4587 • 800-252-1996
www.actionbearing.com

ADMIRAL METALS 5516
11 Forbes Rd
Woburn Massachusetts 01801-2197
800-423-6472 • 781-937-4469
www.admiralmetals.com

Principals:
Hydro
Kaiser Aluminum
KME
Materion
Mueller Brass
Nanshan
North American Stainless
Outokumpu
Revere Copper
Valbruna

ADVANCE WELDING 5870
150 Brookdale Dr
Springfield Massachusetts 01104
413-734-4544 • 413-734-4784
www.theperfectweld.com/

ADVANCED COATING SERVICE 5624
15 Hytec Cir
Rochester New York 14606-4255
585-247-3970 • 585-247-3971
www.acscoating.com

ADVANCED MACHINE & ENGINEERING 5843
2500 Latham St
Rockford Illinois 61103-3972
815-962-6076 • 815-962-6483
www.ame.com

Principals:
Triag

ADVANCED SUPERABRASIVES, INC. 1156
See Saacke North America LLC

ADVENT TOOL & MANUFACTURING INC. 5469
See Cutler Industrial Sales

AER CONTROL SYSTEMS LLC 5762
36 Nettleton Avenue
North Haven Connecticut 06473
203-772-4700 • 203-772-0020
www.aercontrolsystems.com

AERODYNAMICS INC 5482
142 Batchelder Rd
Seabrook New Hampshire 03874-4403
603-474-2547
www.aerodynamicsmetalfinishing.com

AEROSPACE ALLOYS INC 5729
11 Britton Dr
Bloomfield Connecticut 06002-3616
860-882-0119 • 860-882-0967
www.aalloys.com

AIMTEK INC 2108
201 Washington St
Auburn Massachusetts 01501-3224
508-832-5035 • 508-832-5043
www.aimtek.com

AIR CLEANING SPECIALIST 5509
See Blast & Wash Systems

AIR FILTRATION SYSTEMS 3059
231 Wickford Point Rd
N Kingstown Rhode Island 02860
877-410-1887 • 239-303-2507
www.air-filtrationsystems.com

AIR INC 3039
8 Forge Parkway
Franklin Massachusetts 02038-3138
800-341-2800 • 508-528-7050
www.airinc.net

AIR TURBINE TOOLS 5753
1225 Broken Sound Pkwy Ste D
Boca Raton Florida 33487-3500
561-994-0500 • 561-994-8097
www.airturbinetools.com

AIRFLOW SYSTEMS INC 3309
11221 Pagemill Rd
Dallas Texas 75243-8314
214-503-8008 • 214-503-9596
www.airflowsystems.com

AIRGAS 1656
130 Cross Road
Waterford Connecticut 06385
855-625-5285 • 860-444-3056
www.airgas.com

Principals:
Machitech Automation
Miller Electric

AIRLINE HYDRAULICS CORP 1820
3557 Progress Dr
Bensalem Pennsylvania 19020-5896
800-999-7378 • 215-638-1707
www.airlinehyd.com

AIRLOC CORP 5769
5 Fisher St
Franklin Massachusetts 02038-2114
508-528-0022 • 508-528-7555
www.airloc.com

AJAX TOCCO MAGNETHERMIC CORP 1026
1745 Overland Ave
Warren Ohio 44483-2860
330-372-8703 • 330-372-8608
www.ajaxtocco.com

AKS CUTTING SYSTEMS INC 1846
4905 Rocky River Dr
Cleveland Ohio 44135-3245
216-267-1818
www.akscutting.com

ALBION CASTERS 3338
See W T Hight CO

ALEXANDRIA METAL FINISHERS 5742
9418 Gunston Cove Rd
Lorton Virginia 22079-2314
703-643-1636
www.alexandriametalfinishers.com

ALLIANCE FOR AMERICAN MANUFACTURING 3229 711 D Street NW 3rd Floor Washington District of Columbia 20004 202-695-8109 • 800-915-4610 www.americanmanufacturing.org	ALPINE BEARING CO 5669 298 Lincoln St Boston Massachusetts 02134 617-254-1420 • 617-783-5263 www.alpinebearing.com	AMBRELL INDUCTION HEATING SOLUTIONS 2008 39 Main St Scottsville New York 14546-1356 585-889-9000 • 585-889-4030 www.ambrell.com
ALLIED MACHINE & ENGINEERING 5453 120 Deeds Dr Dover Ohio 44622-9652 330-343-4283 • 330-602-3400 www.alliedmachine.com	AMADA GRINDERS 1620 See Ross Machinery Sales Inc	AMERICAN SOCIETY OF MECHANICAL ENGINEERS 5751 2 Park Avenue 6th Floor New York New York 10016-5990 212-591-8500 • 212-591-7674 www.asme.org
ALORIS TOOL TECHNOLOGY CO INC 5332 407 Getty Ave Clifton New Jersey 07011-2121 973-772-1201 • 973-772-8606	AMADA MACHINE TOOLS AMERICA 1754 2324 Palmer Drive Schaumburg Illinois 60173 847-285-4800 • 847-519-2127 www.amadamt.com	AMERICAN SYSTEMS & EQUIPMENT CORP 1022 66 Industry Ave Ste 12 Springfield Massachusetts 01104-3243 413-739-8170 • 413-739-7964 www.american-sys.com
ALPHA ADDITIVE MANUFACTURING TECHNOLOGIES 5615 150 Western Avenue Unit 3 Lowell Massachusetts 01851 888-201-6874 • 800-372-0065 www.alphaamt.com	AMADA MARVEL INC 2114 3501 Marvel Dr Oshkosh Wisconsin 54902-7115 920-236-7200 • 920-236-7209 www.marvelsaws.com	<i>Principals:</i> Kuraki America
ALPHA GRAINGER MANUFACTURING 5683 20 Discovery Way Franklin Massachusetts 02038-2555 508-520-4005 • 508-520-4185 www.agmi.com	AMADA MIYACHI AMERICA 2101 1820 S Myrtle Ave Monrovia California 91016-4833 626-303-5676 • 626-358-8048 www.amadamiyachi.com	AMF 5146 See Platinum Tooling
ALPHA LASER - US 2105 7799 McHenry St Meadville Pennsylvania 16335-9004 814-336-9000 • 814-724-1590 www.alphalaser-us.com	<i>Representatives:</i> The Hanson Group LLC 215-962-5467 • Huntingon Valley Pennsylvania Assembly Manufacturing Technologies 617-548-9955 • Newton Massachusetts RJM Sales 508-966-0270 • Bellingham Massachusetts	ANCA INC 1244 31129 Century Dr Wixom Michigan 48393-2073 248-926-4466 • 248-926-4475 www.anca.com



**HERMES
AWARD**
Nominated for 2018



#1 LASER



May 14-16, 2019
BOOTH #2105

FOR INJECTION MOLD REPAIR, HERMETICALLY SEALED DEVICES, TOOL & DIE REPAIR, AND LASER POWDER CLADDING

Our lasers are the most flexible, efficient, effective, reliable, and simply the best systems on the market.

We are willing to back this up with live demos, no matter the application.



ALFLAK - LASER WELDER



ALM - LASER WELDER

INDISPUTABLY THE BEST LASERS ON THE MARKET

Request Demo |

T: 814-336-9000

E: Sales@alphalaser-us.com

www.alphalaser-us.com

ANOPLATE CORP 459 Pulaski St Syracuse New York 13204-1134 315-471-6143 • 315-471-7132 www.anoplate.com	5726	ARMOLOY OF CONNECTICUT INC 151 Enterprise Drive Bristol Connecticut 06010-8409 860-583-7088 • 860-585-5834 www.armoloyct.com	5246	AUTODESK INC One Market Street Suite 500 San Francisco California 94105 877-335-2261 • 385-202-2631 www.autodesk.com/make	5326
ANTAIRA See CPU Automation Inc	3145	ARNO See Turpin Sales & Marketing Inc	5570	AUTOFORM ENGINEERING USA INC 755 W Big Beaver Rd # 300 Troy Michigan 48084-4900 248-269-4000 • 248-269-8682 www.autoform.com	5467
APPLIED AIR SYSTEMS 5555 S Westridge Dr New Berlin Wisconsin 53151-7900 800-236-8450 www.hastingsair.com	324	ARNOLD SUPPLY INC 67 S Turnpike Rd Wallingford Connecticut 06492-3400 203-265-7168 • 203-265-1032 www.arnoldsupplyinc.com	5548	<i>Representatives:</i> 888-428-8636 • Troy Michigan Grand Rapids Michigan	
AQUAJET CUTTING TECHNOLOGY 11 Britton Dr Bloomfield Connecticut 06002-3616 860-882-0019 • 860-882-0967 www.aquajetct.com	1654	ATAGO USA INC 11811 NE 1st St Ste 101 Bellevue Washington 98005-3050 425-637-2107 • 425-637-2110 www.atago-usa.net	5745	AUTOMATIC LUBE SYSTEMS INC PO Box 1311 Southwick Massachusetts 01077-1311 844-582-3797 www.automaticlubesystems.com	5869
AQUEST CORP 626 Main St PO Box 777 Somers Connecticut 06071-2119 860-749-3938 • 860-749-9913 www.aquestcorp.com	3347	ATLAS COPCO TOOLS/PALMAC 10 Kidder Rd Ste 4 Chelmsford Massachusetts 01824-3375 978-390-2468 • 978-455-0672 www.palmac.net	1134	<i>Principals:</i> DropsA Lubrication Systems	
ARCH CUTTING TOOLS & BEAMER LASER MARKING SYSTEMS 2600 S Telegraph Rd Bloomfield Hills Michigan 48302 810-618-7711 www.archglobalprecision.com	5666	ATRUMP MACHINERY INC 670 Union Ave Pomona California 91768-2058 909-623-6887 • 909-922-7596 www.atrump.com	1762	AUTOMATION ENGINEERING CO 977 E Main St PO Box 866 Torrington Connecticut 06790-6809 860-482-9131 • 860-482-0606 www.automationengrco.com	5759
		<i>Representatives:</i> Sorel Machine Tool 413-977-3765 • Westfield Massachusetts		<i>Principals:</i> Hypneumat/Commander/Snow Inter-Lakes Bases, Inc. Jorgensen Conveyors, Inc. RUF Briquetting Systems Sugino Corp. UNTHA Shredding Technologies	



Saving Thru Throughput

With six decades of experience in EDM, our in-depth solutions to improve throughput can deliver the most effective EDM manufacturing solutions to your challenges. No matter the size of your application, Belmont has an SY Series Small Hole EDM Drill to meet your needs.

We Improve Throughput through:

- Unattended Machine Time
- Automation & Robotics Systems
- Application Specific Material Selection
- Turn-Key Project Design and Engineering



"Everything for EDM"

eastec
May 14-16, 2019
Booth 1248

Michigan • North Carolina • Massachusetts • California • Illinois
800.356.4811 • www.belmont4edm.com



<p>AXIS NEW ENGLAND 3328 6 Cherry Hill Dr Danvers Massachusetts 01923-2575 978-774-7100 • 781-937-9966 www.axisne.com</p> <p><i>Principals:</i> Copley Controls LMI Moxa Omron Parker Hannifin Robotiq Universal Robots Yaskawa America, Inc.</p>	<p>BELMONT EQUIPMENT & TECHNOLOGIES 1248 32055 Edward Ave Madison Hts Michigan 48071-1419 248-588-7011 • 248-588-3337 www.belmont4edm.com</p> <p>BELMONT EQUIPMENT AND TECHNOLOGIES 1620 See Ross Machinery Sales Inc</p> <p>BENZ INCORPORATED 5544 1095 6th Street Ct SE Hickory North Carolina 28602 704-529-5300 • 704-529-5009 www.benztooling.com</p> <p><i>Representatives:</i> 704-529-5300 • Hickory North Carolina</p>	<p>BLASER SWISSLUBE INC 5648 31 Hatfield Ln Goshen New York 10924-6712 845-294-3200 • 845-294-3102 www.blaser.com</p> <p>BLASER-SWISSLUBE 1118 See Lindco Springfield Co</p> <p>BLAST & WASH SYSTEMS 5509 9401 State Route 21 Wayland New York 14572-9410 585-384-9025 www.blastwashsystems.com</p> <p><i>Principals:</i> Air Cleaning Specialist Blast it All Diversitech Air Filtration Force Automation Gibson Abrasive Equipment JRI/JenFab Wash Systems Vapor Honing Technologies</p>
B		
<p>BABIN MACHINE TOOL 1743 14 Upland Rd Brockton Massachusetts 02301-2326 508-588-9189 • 508-588-9121 www.babinmachine.com</p> <p>BARON-BLAKESLEE 5440 See Mikro Industrial Finishing Co</p> <p>BAUMER 3301 See Minuteman / Empire Automation Systems</p> <p>BEHRINGER SAWS INC 2000 721 Hemlock Rd Morgantown Pennsylvania 19543-9768 610-286-9777 • 610-286-9699 www.behringersaws.com</p>	<p>BIG KAISER PRECISION TOOLING INC 5248 2600 Huntington Blvd Hoffman Estates Illinois 60192 224-770-2999 • 224-770-2997 www.us.bigkaiser.com</p> <p>BLACKHAWK / KENNAMETAL 5563 40 Bowles Rd Agawam Massachusetts 01001-2923 413-739-3885 www.bhid.com</p> <p><i>Principals:</i> Kennametal</p>	<p>BLAST IT ALL 5509 See Blast & Wash Systems</p> <p>BLUE PHOTON TECHNOLOGY & WORKHOLDING SYSTEMS LLC 5734 1002 Industrial Park Dr Shelby Michigan 49455-9202 855-777-2040 www.bluephotongrp.com</p> <p><i>Representatives:</i> F&L Technical Sales, Inc. 413-374-9230 • Russell Massachusetts Ed Meltzer & Associates, Inc. 908-903-0191 • Millington New Jersey</p>

EXPERIENCE THE ECONOMY OF QUALITY

Invest in world-class **BIG KAISER** tooling, workholding and measuring systems to increase tool life, reduce cycle time and eliminate scrap.

BIG KAISER delivers the most accurate and efficient tooling solutions – guaranteed.

eastec[®]

SEE US AT EASTEC 2019 — BOOTH 5248



BIG KAISER



Tool Holders | Boring Tools | Cutting Tools | Workholding | Tool Measuring | bigkaiser.com

BLUM-NOVOTEST, INC. See Caron Engineering Inc	5432	BUFFOLI NORTH AMERICA 4508 128th Ave Holland Michigan 49424-9257 800-795-5536 www.buffoli.com	2041	BUTLER BROS 2001 Lisbon Rd PO Box 1375 Lewiston Maine 04240-1311 888-784-6875 • 207-786-8820 www.butlerbros.com	5637
BODYCOTE THERMAL PROCESSING 45 Connecticut Ave South Windsor Connecticut 06074-3475 860-282-1376 www.bodycote.com	2031	BURR KING MANUFACTURING CO 1220 Tamara Ln Warsaw Missouri 65355-3346 660-438-8998 • 660-438-8991 www.burrrking.com	1713	BUWW COVERINGS INC 4462 Boeing Dr Rockford Illinois 61109-2931 815-962-2899 • 815-962-2897 www.buww.com	3335
BONAL TECHNOLOGIES INC 1300 North Campbell Road Royal Oak Michigan 48067-1573 248-582-0900 • 248-582-0901 www.bonal.com	1136				
BOSTON LASER TECH 1 Presidential Way Ste 107 Woburn Massachusetts 01801-1071 857-286-9933 www.blazer-tech.com	5722				
BOSTON TOOLING AND MACHINING ASSOCIATION SPONSORED BY COMPUMACHINE PO Box 95 Dracut Massachusetts 01826-0095 978-457-5881 www.bostontooling.org	5245				
<i>Representatives:</i> Connecticut Tooling & Machining Association 860-604-8963 • Bristol, Connecticut Western Massachusetts Chapter of the National Tooling and Machining Association 413-219-6111 • Feeding Hills MA Massachusetts					
BOYUM SOLUTIONS PO Box 708 Crystal Beach Florida 34681-0708 727-773-2900 www.boyum-solutions.com	5868				
BRANSON ULTRASONICS CORP 41 Eagle Rd Danbury Connecticut 06813 203-796-0400 • 203-796-0450 www.bransonultrasonics.com	3235				
BRETON MACHINE TOOLS See Ross Machinery Sales Inc	1620				
BRINEY TOOLING SYSTEMS See Fullerton Tool Co	5736				
BRISTOL TAPE CORPORATION 598 Airport Rd Fall River Massachusetts 02720-4735 800-336-5941 • 508-673-9570 www.btctape.com	5851				
BROOK ANCO CORPORATION 7536 W Murray Dr Cicero New York 13039-9773 800-388-7566 www.brookanco.com	2110				
BROOKS ASSOC INC 300 Longwater Drive Norwell Massachusetts 02061 860-460-9664 • 509-272-8836 www.brooksmachinery.com	1206				
BRUKER CORPORATION 415 N Quay St Kennewick Washington 99336 508-783-9850 • 509-735-9696 www.brucker.com/hhxf	3026				
BRUSH RESEARCH MANUFACTURING CO 4642 Floral Drive Los Angeles California 90022-1244 323-261-2193 • 323-268-6587 www.brushresearch.com	5608				



“The best coolant I’ve ever used. My guys love it.”

Find out which coolant is Titan Gilroy’s clear choice: blaser.com/synergy735

Blaser Swisslube Inc.
Goshen, New York 10924, Phone 845-294-3200, www.blaser.com, mailboxusa@blaser.com

See us at Booth #5648

C

C2G 3020
6500 Poe Ave
Dayton Ohio 45414-2527
800-506-9607
www.cablestogo.com

CAD BLU INC 5840
37 W 28th Street 9th Floor
New York New York 10001-4203
212-481-8700 • 212-481-8737
www.cadblu.com

CAFRO BONDED ABRASIVES 1711
See Mirka / Cafro

CAMBRIDGE VACUUM ENGINEERING 5857
630 Silver St Unit 7
Agawam Massachusetts 01001-2940
413-789-4600 • 413-786-0508
www.camvaceng.com

CAMWORKS 5452
See Access Manufacturing Systems

CAPTURE 3D INC 3044
Headquarters 3207 S Shannon St
Santa Ana California 92704
714-546-7278
www.capture3d.com

CARBIDE GRINDING CO INC 5341
W226N735 Eastmound Dr
Waukesha Wisconsin 53186-1695
866-888-9600
www.gorillamill.com

CARBIDE RELATED TECHNOLOGIES, INC. 5765
See HPM Technologie GmbH

CARLSON FABRICATION SOLUTIONS 2128
2 Rainin Road
Woburn Massachusetts 01801
781-937-9599
www.carlsonfab.com

CARMEX PRECISION TOOLS LLC 5016
2075 State Hwy 175 PO Box 283
Richfield Wisconsin 53076
262-628-5030 • 262-628-5302
www.carmexusa.com

CARON ENGINEERING INC 5432
116 Willie Hill Rd
Wells Maine 04090
207-646-6071 • 207-646-6983
www.caroneng.com

Principals:
Blum-Novotest, Inc.

Representatives:
Blum-Novotest
859-344-6789 • Erlanger Kentucky
Newman M2M
704-519-9598 • Rock Hill South Carolina
Ovation Engineering Wolfram Manufacturing
Eagle Vision and Automation
Prime Technical Services • Medina Ohio

**CARR LANE MANUFACTURING/
CARR LANE ROEMHOLD** 5659
4200 Carr Lane Ct
Saint Louis Missouri 63119-7970
314-647-6200 • 314-647-1446
www.carrlane.com

CEIA USA INDUCTION HEATING SYSTEMS 1243
9155 Dutton Dr
Twinsburg Ohio 44087-1956
330-405-3190 • 330-405-3196
www.ceia-usa.com

CENTAUR PRECISION TOOLS INC 5512
13098 SW 133rd Ct
Miami Florida 33186-5855
305-232-1496 • 305-251-0756
www.centaurtools.com

CENTER FOR MANUFACTURING TECHNOLOGY 5582
See The Custom Group Center For Manufacturing Technology

CERATIZIT 1118
See Lindco Springfield Co

CERATIZIT USA INC 5263
11355 Stephens Rd
Warren Michigan 48089-1802
800-783-2280 • 586-759-1657
www.ceratizit.com

Air Gap Sensors Giving You Trouble?



Here's Your Solution:

Air Rest Buttons
carrlane.com/mysolution

Take the guesswork out of loading your parts. Whether you run your operations with robot or human guidance, Carr Lane Manufacturing's Air Rest Buttons deliver feedback with every load.

CarrLane
MANUFACTURING CO.
www.carrlane.com
314-647-6200

See these and other
CLM products at
Eastec
Booth 5659

CERTIFIED COMPARATOR PRODUCTS (CCP)
See Quality Vision International

3003

CGTECH

9000 Research Dr
Irvine California 92618
949-753-1050 • 949-753-1053
www.cgtech.com

5350

CHAMBRELAN SAS

68 bd Jules Durand BP 995
Le Havre Cedex Normandie 76061
France
33(023)5246280
www.chambreлан.com

2130

Representatives:

Chambreлан Industrial Slides Inc.
514-980-4086 • Montreal Quebec
Allied International
914-241-6900 • Bedford Hills New York

**CHAPIN & BANGS STEEL CO/
LINDQUIST STEELS INC**

165 River St
Bridgeport Connecticut 06604-2922
203-333-4183 • 203-334-8538
www.cbsteel.com

5012

CHEMETALL US INC

675 Central Ave
New Providence New Jersey 07974-1560
908-464-6900 • 908-464-2377
www.chemetallNA.com

3234

**CHICAGO PNEUMATIC
TOOL COMPANY LLC**

1815 Clubhouse Road
Rock Hill South Carolina 29730
800-624-4735
www.cpc.com

5824

CHUMPOWER MACHINERY CORP

No.688-1, Sec. 3, Zhong-Shan Rd.,
Wuri Township 41453
Taiwan
+886-4-2338-8289 • +886-4-2336-5626
www.chuck-tools.chumpower.com

5770

CIMCO AMERICAS LLC

810 Leesport Ave
Leesport Pennsylvania 19533-9505
704-644-3587 • 704-943-0514
www.cimco.com

5716

CIMCO WIRELESS DNC

See Cimquest Inc

5036

CIMCOOL FLUID TECHNOLOGY

3000 Disney St
Cincinnati Ohio 45209-5028
513-458-8100 • 513-458-8179
www.cimcool.com

5823

CIMQUEST INC

3434 Us Highway 22 Ste 130
Branchburg New Jersey 08876-6011
866-277-8778
www.cimquest-inc.com

5036

Principals:

Cimco Wireless DNC
Desktop Metal
Formlabs
Geomagic
HP Jet Fusion 3D
Mastercam
Mcor Technologies
Rize - Full-Color Industrial 3D Printing
Shining 3D
Verisurf

CINCINNATI INC

7420 Kilby Rd
Harrison Ohio 45030-8915
513-367-7100 • 513-367-7592
www.e-ci.com

1844

CITY OF BRISTOL CT

111 N Main St
Bristol Connecticut 06010-8112
860-584-6185

5871

CLAMPTEK USA INC

No. 13 Ln. 258, Sec 1, Jianguo S. Rd., Da'an Dist.
Taipei City California 92821
562-315-7770
www.clamptek.us

5684

VERICUT®
CNC Machine Simulation Software

CNC Machine Simulation, Verification, & Optimization Software

CRASH DETECTED!

**SAVE TIME • SAVE MONEY
SAVE YOUR MACHINES**

Right the first time. Every time.

9000 Research Dr, Irvine, California 92618
(949) 753-1050 • info@cgtech.com

CGTECH.com

easteec Booth #5350
rapid + tct Booth #430

CLEANING TECHNOLOGIES GROUP 3219 4933 Provident Dr Cincinnati Ohio 45246 800-248-2974 • 513-870-0105 www.ctgclean.com	CPU AUTOMATION INC 3145 164 Westford Rd Ste 3 Tyngsboro Massachusetts 01879-2530 978-226-1633 • 978-226-1634 www.cpuauto.com	D
CLM VIBETECH 5440 See Mikro Industrial Finishing Co	<i>Principals:</i> Antaira Dynics Inc. EXM Grace Engineered Products Infranor Sanyo Denki Swivellink Teledyne Dalsa Unitronics Wieland	DA/PRO RUBBER INC 340 601 N Poplar Broken Arrow Oklahoma 74012 918-258-9386 • 918-258-3286 www.daprorubber.com
CLOMEA / 3C 5820 See J&S Machine Inc	CREST ULTRASONICS CORP 3058 18 Graphics Drive Ewing Township New Jersey 08628-0000 203-910-5759 • 609-883-6452 www.crest-ultrasonics.com	DAKE 5469 See Cutler Industrial Sales
CMS NORTH AMERICA INC 1842 4095 Karona Ct SE Caledonia Michigan 49316-8428 800-225-5267 www.cmsna.com	CUBIC MACHINERY INC 1021 13401 Benson Ave Chino California 91710-5231 909-590-9995 • 909-590-9996 www.cubicmachinery.com	DAPRA MARKING SYSTEMS 2037 66 Granby St Bloomfield Connecticut 06002-3512 800-442-6275 • 860-242-3017 www.dapramarking.com
CNC SYSTEMS INC 1328 40 Water St Kennebunk Maine 04043-7034 207-985-6503 • 207-985-4132 www.cncsystems.com	CURBELL PLASTICS INC 5771 850 Prospect Hill Road Windsor Connecticut 06095 860-298-7980 • 860-298-7988 www.curbellplastics.com	DAREX LLC 5676 210 East Hersey Street PO Box 730 Ashland Oregon 97520-0730 541-488-2224 • 541-488-2229 www.darex.com
COLSON CASTER 3338 See W T Hight CO	CURRENT EDM INC 1255 2577 Leghorn St Mountain View California 94043-1613 650-966-9676 • 650-966-1881 www.currentedm.com	DASSAULT SYSTEMES 5233 See Macdac Engineering
COMCO INC 5545 2151 N Lincoln St Burbank California 91504-3392 818-841-5500 • 818-955-8365 www.comcoinc.com	CUSTOM SERVICE SOLUTIONS INC 3218 1900 Transit Way Brockport New York 14420 585-520-2810 www.cssflys.com	DATRON DYNAMICS INC 5240 115 Emerson Rd Milford New Hampshire 03055-3583 603-215-5847 • 603-672-8067 www.datron.com
CONLEY CASTING SUPPLY CORP 5739 124 Maple Street Warwick Rhode Island 02888-2188 401-785-9500 • 401-781-9420 www.conleycasting.com	<i>Representatives:</i> A&M Industrial 800-864-2660 • Rahway New Jersey Marubeni Citizen-Cincom, Inc. 413-786-6655 • Agawam Massachusetts The Robert E. Morris Company 860-687-3300 • Windsor Connecticut	DCM TECH INC 1125 4455 Theurer Blvd Winona Minnesota 55987-1593 507-452-4043 • 507-452-7970 www.dcm-tech.com
<i>Representatives:</i> Conley Casting UK +44-798-355-8338 • Birmingham, England UK	CUTLER INDUSTRIAL SALES 5469 160 Irish Ln Islip Terrace New York 11752-2110 631-277-4930 • 631-581-6968 www.cutlersales.com	DECADE PRODUCTS INC 3317 3710 Sysco Ct SE Grand Rapids Michigan 49512-2043 616-975-4965 • 616-254-4259 www.decadeproducts.com
CONTOUR360 5559 5 Industrial Way Cornish Maine 04020-3246 207-625-4000 • 207-625-9389 www.contour360.com	<i>Principals:</i> Advent Tool & Manufacturing Inc. Dake H & R Huot Manufacturing Lexington Cutter MAYFRAN Royal Products Samchully Workholding	DECOSMO INDUSTRIAL AUCTIONS & THOMAS INDUSTRIAL MACHINERY CO INC 1239 PO Box 569 Agawam Massachusetts 01001-0569 413-530-0019 • 413-301-8786 www.diauctions.com
CONTROL GAGING INC 3224 847 Avis Drive Ann Arbor Michigan 48108-9615 734-668-6750 • 734-994-1335 www.controlgaging.com	CUTTING TOOL ENGINEERING MAGAZINE 3315 1 Northfield Plaza >Ste 240 Northfield Illinois 60093 847-714-0176 • 847-559-4444 www.ctemag.com	DELUXE SYSTEMS 3340 42 Winter St Ste 18 Pembroke Massachusetts 02359-4958 800-242-0962 • 508-586-6759
CONTROX INC 5571 5776 Urbana Rd Springfield Ohio 45502-9582 800-558-8966 • 937-325-1418 www.controx.com		DENNISON LUBRICANTS 5662 111 Rhode Island Rd Lakeville Massachusetts 02347-1363 508-946-0500 • 508-946-3400 www.denlube.com
COOL GRIND TECHNOLOGIES 1745 673 Chaffeeville Road Storrs-Mansfield Connecticut 06268 860-429-8822 www.cool-grind.com		<i>Principals:</i> Dennison Lubricants Shell Lubricants Summit
COPLEY CONTROLS 3328 See Axis New England		DESIGN 2 PART MAGAZINE 5725 16 Waterbury Rd Prospect Connecticut 06712-1255 800-225-4535 • 203-758-3427
COSEN SAWS 2142 4527 Dwight Evans Road Charlotte North Carolina 28217 704-943-1030 • 704-943-1031 www.cosensaws.com		DESKTOP METAL 5036 See Cimquest Inc

Meet New Suppliers & See New Technologies

DESIGN **2** PART
SHOWS

at America's Premier Design & Contract Manufacturing Trade Shows!

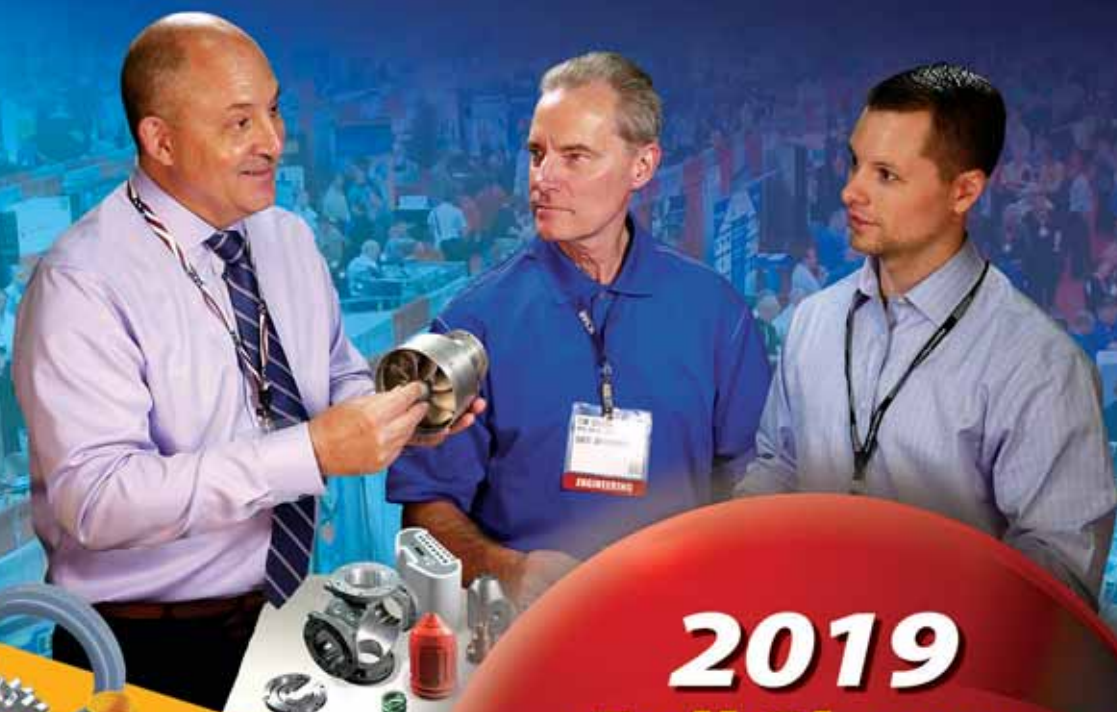

2019 Fall Shows

Marlborough, MA	September 25 & 26
Pasadena, CA	October 9 & 10
Oaks, PA	October 23 & 24
Indianapolis, IN	November 6 & 7
Charlotte, NC	November 13 & 14

- Compare Vendors
- Improve Quality
- Reduce Your Costs

Metal, Plastic, Rubber, Electronics
From Design & Prototypes to Production & Finishing

MADE IN
USA
for over 40 years

@Design2Part

For More Information or for FREE Show Registration, **D2P.com**

DIACUT INC 773 Highway 105 PO Box 217 Palmer Lake Colorado 80133 719-481-4205 • 719-488-0872 www.diacut.com	3226	DYNAMIC INTERNATIONAL N25W23287 Paul Rd Pewaukee Wisconsin 53072-4074 262-521-1100 • 262-521-1244 www.dynamicintl.com	1454	ELECTRODES INC 252 Depot Rd Milford Connecticut 06460-3807 440-391-7445 • 203-882-5981 www.electrodes-inc.com	1128
DIGIPAS TECHNOLOGIES INC 200 Spectrum Center Dr Ste 300 Irvine California 92618-5004 949-558-0160 • 949-271-5701 www.digipas.com	5340	<i>Representatives:</i> Brady Machine Tools 508-400-7069 • Webster Massachusetts Northeast CNC 207-775-5510 • Gorham Maine		ELECTRONIC SERVICE PRODUCTS See Ross Machinery Sales Inc	1620
<i>Principals:</i> Digipas Technologies Inc		DYNICS INC. See CPU Automation Inc	3145	ELM ELECTRICAL 68 Union St Westfield Massachusetts 01085-2496 508-480-9300 www.elmelec.com	1852
DILLON CHUCK JAWS 2115 Progress Rd Springfield Ohio 45505-4470 800-428-1133 • 937-325-8483 www.dillonmfg.com	5537			EM BENSON CO 1486 Highland Ave Cheshire Connecticut 06410-1200 203-271-3880 • 203-271-3915 www.embenso.com	5141
DINO-LITE SCOPES (BIGC) 19803 Hamilton Ave Torrance California 90502 310-618-9990 • 877-978-2787 www.dinolite.us	3143	E		EMAG LLC 38800 Grand River Ave Farmington Hills Michigan 48335-1526 248-477-7440 • 248-477-7784 www.emag.com	1045
DISCUS SOFTWARE COMPANY 829 Bethel Rd Columbus Ohio 43214-1903 614-360-2424 • 866-831-3808 www.DISCUSsoftware.com	3238	EBBCO INC 51536 Industrial Dr New Baltimore Michigan 48047 586-716-5151 • 586-716-4949 www.ebbcoinc.com	1727	EMERSON ASCO & AVENTICS See Minuteman / Empire Automation Systems	3301
DIVERSITECH AIR FILTRATION See Blast & Wash Systems	5509	ECI SOFTWARE SOLUTIONS 4400 Alliance Gateway Freeway Suite 154 Fort Worth Texas 76177-3706 800-959-3367 • 877-622-0262 www.manufacturing.ecisolutions.com	5532	EMUGE CORP 1800 Century Dr West Boylston Massachusetts 01583-2121 508-595-3600 • 508-595-3650 www.emuge.com	5369
DOALL SAWING PRODUCTS 5505 W 123rd St Savage Minnesota 55378-1299 888-362-5572 • 952-707-9791 www.doallsaws.com	2133	ECLIPSE MAGNETICS 442 Millen Rd Suite 9 Stoney Creek Ontario L8E 6H2 Canada 800-260-2124 • 905-664-7090 www.eclipsemagnetics.com/na	3022	ENCON EVAPORATORS 1368 Hooksett Rd Hooksett New Hampshire 03106-1823 603-624-5110 • 603-627-9520 www.evaporator.com	5421
DORINGER COLD SAWS 13400 Estrella Ave Gardena California 90248-1513 310-366-7766 • 310-366-7573 www.doringer.com	2035	<i>Principals:</i> MSC Filtration Technologies		ENGIS CORP 105 W Hintz Rd Wheeling Illinois 60090 847-808-9400 • 847-808-9430 www.engis.com	5028
DORNER MFG See Stamptech Inc	5523	<i>Representatives:</i> MSC Filtration Technologies 860-745-7475 • Enfield Connecticut		ENSITECH INC 1005 N Commons Dr Aurora Illinois 60504-4100 630-851-2126 • 630-851-7744 www.tigbrush.com	5758
DORSEY METROLOGY INTERNATIONAL INC 53 Oakley Street Poughkeepsie New York 12601-2004 845-454-3111 • 845-454-3888 www.dorseymetrology.com	3119	ECM GLOBAL MEASUREMENT SOLUTIONS 428A Boston St Topsfield Massachusetts 01983-1216 978-887-5781 • 978-887-5782 www.eastcoastmetrology.com	3008	EPICOR SOFTWARE CORP 804 Las Cimas Pkwy Austin Texas 78746-5179 800-999-1809 www.epicor.com	3240
DROPSA LUBRICATION SYSTEMS See Automatic Lube Systems Inc	5869	ECOCLEAN INC 26801 Northwestern Hwy Southfield Michigan 48033 248-450-2000 • 248-450-2586 www.ecoclean-group.us/	3019	EPILOG LASER CORP 16371 Table Mountain Pkwy Ste L Golden Colorado 80403-1826 303-277-1188 • 303-277-9669 www.epiloglaser.com	2129
DUBOIS CHEMICALS INC 3630 E Kemper Rd Sharonville Ohio 45241-2011 800-438-2647 • 513-326-8890 www.duboischemicals.com	5449	EDAC TECHNOLOGIES 68 Prospect Hill East Windsor Connecticut 06088 860-789-2500 www.edacmachinery.com	5553	ERCOLINA - CML USA INC 3100 Research Pkwy Davenport Iowa 52806 563-391-7700 • 563-391-7710 www.ercolina-usa.com	1753
DYNABRADE INC 8989 Sheridan Dr Clarence New York 14031-1490 716-631-0100 • 716-631-1167 www.dynabrade.com	5677	EDGE TECHNOLOGIES 11600 Adie Rd St Louis Missouri 63043 314-692-8388 • 314-692-5166 www.edgetechnologies.com	1348		
		EDM NETWORK INC 1974 Bucktail Ln Sugar Grove Illinois 60554-9609 630-466-5588 • 630-466-5599 www.edmnetwork.com	1648		
		EIGHT TOOL AMERICA 11500 Tennessee Ave Unit 105 Los Angeles California 90064-1597 323-630-9614 • 310-496-3272 www.eighttoolamerica.com	5647		

EXHIBITORS

ERGO ADVANTAGE 630 Glengarry Cres PO Box 352 Fergus Ontario N1M 3E2 Canada 519-843-1982 www.ergoadvantageinc.com	5617	FAGOR AUTOMATION CORP 2250 Estes Ave Elk Grove Village Illinois 60007-5427 847-981-1500 • 847-981-1311 www.fagorautomation.com/en	2123
<i>Representatives:</i> Grainger 888-602-0000 • Valen 780-468-3368 • Edmonton Alberta Hubbard 800-875-4811		FANUC See Methods Machine Tools Inc	2034
ERGOTRONIX INC 6408 Parkland Drive Sarasota Florida 34243 877-733-3746 www.ergotronix.com	5144	FANUC AMERICA CORP 3900 W Hamlin Rd Rochester Hills Michigan 48309-3253 248-377-7000 • 248-276-4111 www.fanucamerica.com	1018
EROWA TECHNOLOGY INC 2535 S Clearbrook Dr Arlington Hts Illinois 60005-4623 847-290-0295 • 847-290-0298 www.erowa.com	1628	FANUC ROBOTICS See Methods Machine Tools Inc	2034
ESPRIT/DP TECHNOLOGY CORP 1150 Avenida Acaso Camarillo California 93012-8719 805-388-6000 • 805-388-3085 www.espritam.com	5259	FARO TECHNOLOGIES INC 250 Technology Park Lake Mary Florida 32746-7115 407-333-9911 • 407-333-4181 www.faro.com	3135
EUREKA CHEMICAL CO 234 Lawrence Ave S San Fran California 94080-6863 650-754-6136 • 650-589-1943 www.fluid-film.com	3243	FASTENAL COMPANY 2001 Theurer Blvd Winona Minnesota 55987 877-507-7555 • 507-494-7690 www.fastenal.com	5575
EUREKA MACHINE SIMULATION See Access Manufacturing Systems	5452	<i>Representatives:</i> Fastenal 1-877-507-7555 • Winona Minnesota	
EURO-TECH CORP N48W14170 Hampton Ave Stop 1 Menomonee Falls Wisconsin 53051-6998 262-781-6777 • 262-781-2822 www.pg1000.com	5336	FAULTLESS CASTER See W T Hight CO	3338
EVEREDE TOOL COMPANY 850 West Hawthorne Lane West Chicago Illinois 60185 331-871-5214 • 331-240-2124 www.everede.net	5649	FAXON ENGINEERING 17 Britton Dr Bloomfield Connecticut 06002-3616 860-236-4266 • 860-232-5856 www.faxonengineering.com	1768
EXCELLERANT See Macdac Engineering	5233	FIMOR NA 50 Grandview Ct Cheshire Connecticut 06410-1261 203-272-3219 • 203-272-0428 www.harknessindustries.com	5363
EXM See CPU Automation Inc	3145	FISCHER TECHNOLOGY INC 750 Marshall Phelps Rd Windsor Connecticut 06095-2199 860-683-0781 • 860-688-8496 www.fischer-technology.com	5738
F			
FABRICATING & METALWORKING MAGAZINE 4260 Milner Road East Birmingham Alabama 35242 866-832-8473 • 866-263-2118 www.fabricatingandmetalworking.com	3321	<i>Representatives:</i> Vernier Sales Inc 972-542-6613 • McKinney Texas CMG Sales Inc 847-550-1095 • Lake Zurich Illinois	
FACTORY CAT 1711 South Street Racine Wisconsin 53401 800-634-4060 • 866-901-3335 www.factorycat.com	3339	FISHER UNITECH LLC 404 E 10 Mile Rd Pleasant Rdg Michigan 48069-1201 248-577-5100 • 508-718-2223 www.fisherunitech.com	5054
		FITZ-RITE PRODUCTS INC 1122 Naughton Dr Troy Michigan 48083-1930 248-528-8440 • 248-528-1581 www.fitzrite.com	5645
		FIVES GIDDINGS & LEWIS See Ross Machinery Sales Inc	1620

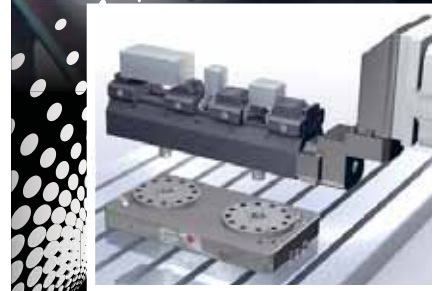

CleverClamp System

The seamless, modular workpiece clamping system. The wide range of available clamping jaws and surfaces hold any workpiece securely and accurately.

Increase productivity by integrating the CleverClamp base rails into your automation system!

eastec[®]

Booth #1628

EROWA[®]
system solutions



MAXIMIZE YOUR PRODUCTIVITY



When you're ready to automate, count on FANUC for reliable products, process expertise and lifetime product support.

VISIT US AT EASTEC 2019, BOOTH 1018

ROBOTS | CNC | ROBOMACHINES

FANUC

888-FANUC-US
www.fanucamerica.com

© 2019 FANUC America Corporation. All Rights Reserved



FIXTUREWORKS 33792 Doreka Fraser Michigan 48026-3430 586-294-1188 • 586-294-4843 www.fixtureworks.net	5766	FRYER MACHINE SYSTEMS INC 70 Jon Barrett Rd Patterson New York 12563-2164 845-878-2500 • 845-878-2525 www.fryermachine.com	1720	GENERAL MANUFACTURING INC 1336 W Wiley Ave Bluffton Indiana 46714-2244 260-824-3440 • 260-824-3448 www.saftlite.com	1863
FLEXARM INC 851 Industrial Dr Wapakoneta Ohio 45895-9243 800-837-2503 • 419-738-8140 www.flexarminc.com	5541	FULLERTON TOOL CO 121 Perry St Saginaw Michigan 48602-1496 800-248-8315 • 989-792-3335 www.fullertontool.com	5736	<i>Representatives:</i> MSC Industrial Direct 516-812-2000 • Melville New York McMaster-Carr Supply Company 630-834-9600 • Chicago Illinois Fastenal Company 507-454-5374 • Winona Minnesota	
<i>Representatives:</i> Mid Atlantic Machinery, Inc. 717-541-1633 • Harrisburg Pennsylvania		<i>Principals:</i> Briney Tooling Systems		GENEVIEVE SWISS INDUSTRIES INC 6 Old Stage Rd Westfield Massachusetts 01085-5118 413-562-4800 • 413-562-4802 www.genswiss.com	5133
FLEXBAR MACHINE CORP 250 Gibbs Rd Islandia New York 11749-2697 631-582-8440 • 631-582-8487 www.flexbar.com	3157			GENIUS ERP 793 Boul Jean Paul Vincent Suite 100 Longueuil Quebec J4G 1R3 Canada 877-812-3605 • 514-227-8317 www.geniuserp.com	5663
FLEXCNC See Northeast Machinery Sales/FlexCNC	1228			GENTIGER MACHINERY INDUSTRIAL CO. LTD No 66 Shuitou 1st Rd Waipu Dist., Taichung City 43856 Taiwan +886-4-26836919 • +886-4-26839900 www.gentiger.com.tw	1061
FLOW INTERNATIONAL CORP 23500 64th Ave S Kent Washington 98032-2305 253-850-3500 • 253-813-9377 www.flowwaterjet.com	1712				
FLUID CHILLERS See MCRL Inc / Fluid Chillers	1001				
FOBA LASER MARKING + ENGRAVING ALLTEC GMBH 1500 Mittel Blvd. Wood Dale Illinois 23923 630-694-3243 www.fobalaser.com/	3341				
FOOTMASTER See W T Hight CO	3338				
FORCE AUTOMATION See Blast & Wash Systems	5509				
FORMLABS See Cimquest Inc	5036				
FORTUNE METAL FINISHING CORP 116 Gould St Needham Massachusetts 02494-2697 781-449-4160 • 781-449-4621 www.fortunemetal.com	5414				
FOWLER HIGH PRECISION See L.F.O'leary Co.Inc/ Glastonbury Southern Gage	3254				
FOWLER HIGH PRECISION INC 66 Rowe St Auburndale Massachusetts 02466-0996 617-332-7004 • 617-332-4137 www.fowlerprecision.com	3251				
FRONIUS USA LLC 6797 Fronius Drive Portage Indiana 46368 219-734-5500 • 219-734-5502 www.fronius.us	1737				
FRONT PANEL EXPRESS 5959 Corson Ave South Ste I Seattle Washington 98108-2605 206-768-0602 • 206-768-0679 www.frontpanelexpress.com	5568				

G

G II SOLUTIONS INC 201 Bank St PO Box 428 Central South Carolina 29630-9291 864-639-6605 • 864-639-4056 www.giisolutions.com	1253
GARBOLI See J&S Machine Inc	5820
GEBR. SAACKE GMBH & CO. KG See Saacke North America LLC	1156

GF Machining Solutions



AgieCharmilles
CUT C series

Cutting costs

With a state-of-the-art generator and hardware, the AgieCharmilles CUT C series is designed to guarantee the best performance while maintaining low operating costs. The CUT C 350 has axis travels of 350 mm in X and 250 mm in Y for the introductory price of \$99,000 USD. For larger workpieces, the CUT C 600 has travels of 600 mm in X and 400 mm in Y for \$118,000 USD.

Learn how GF is the solution for your next project.

www.gfms.com/us



Introducing high quality without the high price
\$99,000
(CUT C 350)

+ We are AgieCharmilles.
+ We are GF Machining Solutions.

Visit us at **eastec 2019** at Booth #1420

GEOMAGIC See Cimquest Inc	5036	<i>Representatives:</i> 781-769-3600 • Norwood Massachusetts			
GESSWEIN CO 201 Hancock Ave Bridgeport Connecticut 06605-2405 203-366-5400 • 203-366-3953 www.gesswein.com	5653	GKS LIFTING AND MOVING SOLUTIONS LLC 202 North Limestone St Springfield Ohio 45503 937-324-8867 • 937-324-8171 www.gksweb.com	3325	GREENLEAF CORP 18695 Greenleaf Dr PO Box 1040 Saegertown Pennsylvania 16433-4429 814-763-2915 • 814-763-4423 www.greenleafglobalsupport.com	5317
GF MACHINING SOLUTIONS See Ross Machinery Sales Inc	1620	GLASTONBURY SOUTHERN GAGE See L.F.O'leary Co.Inc/ Glastonbury Southern Gage	3254	GRIFFO BROTHERS INC 2101 NE Jack London St Corvallis Oregon 97330 541-758-8421 • 541-754-7305 www.griffobros.com	5034
GF MACHINING SOLUTIONS 560 Bond St Lincolnshire Illinois 60069-4207 847-913-5300 • 847-955-7170 www.gfms.com/us	1420	GMA GARNET 1780 Hughes Landing Suite 725 The Woodlands Texas 77380 832-243-9300 • 832-243-9301 www.garnetsales.com	1719	GROBET USA 750 Washington Ave Carlstadt New Jersey 07072-3008 201-939-6700 • 201-939-5067 www.grobetusa.com	5520
GH INDUCTION ATMOSPHERES LLC 35 Industrial Park Cir Rochester New York 14624-2403 585-368-2120 • 585-368-2123 www.gh-ia.com	2033	GODEX INTERNATIONAL AMERICAS 4023 Camino Ranchero Ste A Camarillo California 93012-5153 888-987-8878 • 805-987-5115 www.godexintl.com/us	5622	GTI SPINDLE TECHNOLOGY INC 33 Zachary Rder Manchester New Hampshire 03109-5639 888-473-9675 • 603-669-8996 www.gtispindle.com	5562
GIBSON ABRASIVE EQUIPMENT See Blast & Wash Systems	5509	GRACE ENGINEERED PRODUCTS See CPU Automation Inc	3145		
GIBSON ENGINEERING CO INC 90 Broadway Norwood Massachusetts 02062-3519 781-769-3600 • 781-769-8455 www.gibsonengineering.com	3045	GRADIENT LENS CORPORATION 207 Tremont St Ste 1 Rochester New York 14608-2303 585-235-2620 • 585-235-6645 www.gradientlens.com	3150		

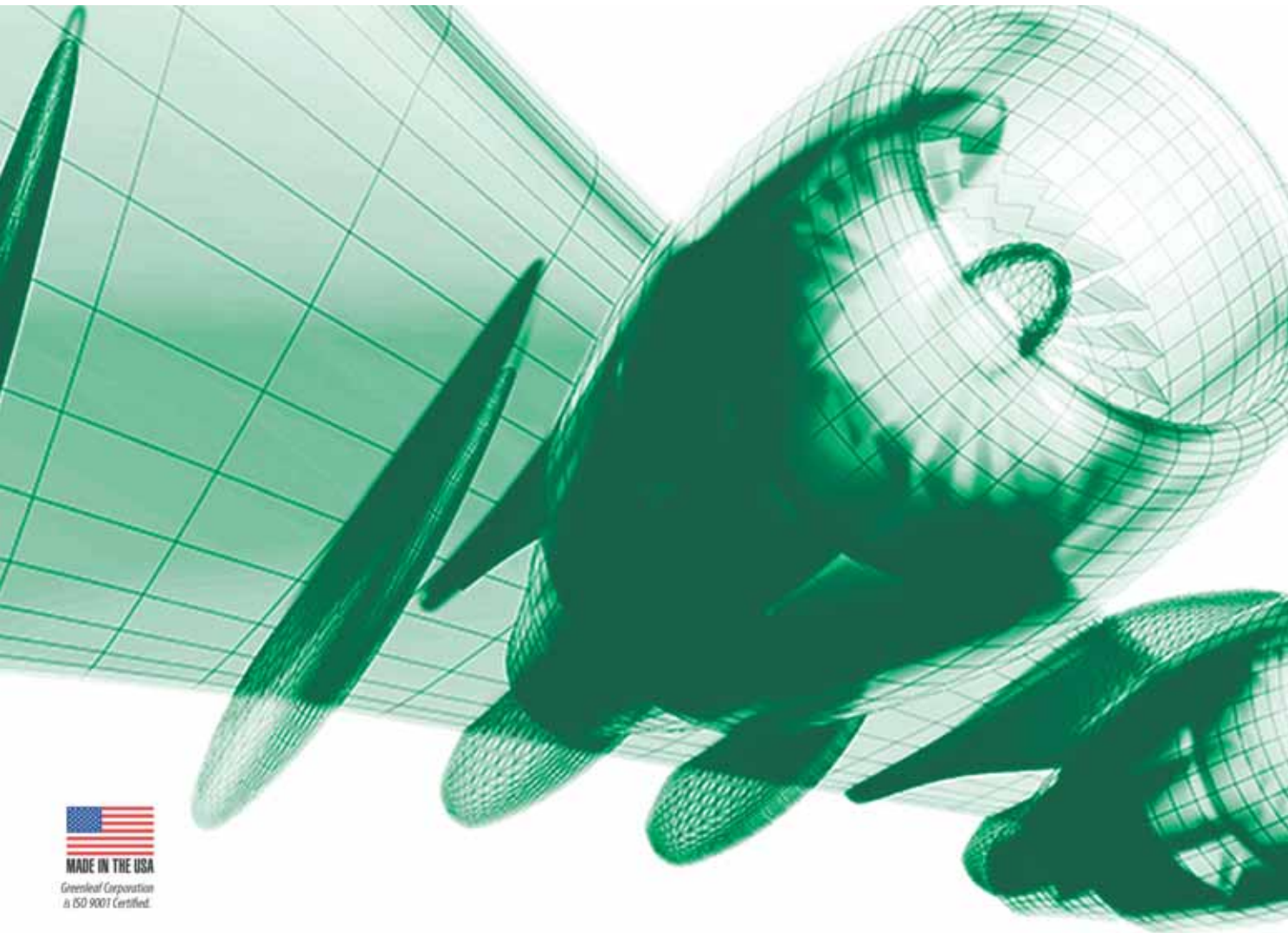

GUHRING INC 1445 Commerce Ave Brookfield Wisconsin 53045-5289 262-787-3114 • 262-784-1984 www.guhring.com	5333	HAAS MULTIGRIND 137 Enterprise Dr Warsaw Indiana 46580-1204 574-268-0053 • 574-268-0083 www.multigrind.com	1051	HARDINGE INC One Hardinge Drive Elmira New York 14903 800-843-8801 • 607-734-8819 www.hardinge.com	5444
<i>Representatives:</i> Butler Bros 781-961-2771 • Randolph Massachusetts Blackhawk Industrial 413-739-7183 • Agwam Massachusetts DXP / formerly Kenneth Crosby 508-497-0048 • Hopkinton Massachusetts		HAIMER See Lindco Springfield Co	1118	HARDLINE HEAT TREATING INC 134 Ashland Ave Southbridge Massachusetts 01550 508-764-6669 • 508-764-6654 www.hardlineheattreating.com	2011
GWS TOOL GROUP 595 County Road 448 Tavares Florida 32778-6109 877-497-8665 • 352-343-8311 www.gwstoolgroup.com/	5621	HAIMER USA 134 E Hill St Villa Park Illinois 60181-1805 630-833-1500 • 630-833-1507 www.haimer-usa.com	5458	HARVEY INDUSTRIES INTERNATIONAL INC 10830 Ada Ave Montclair California 91763-6250 888-211-0397 www.harveywoodworking.com	3343
GWS/BENCHMARK CARBIDE See Lindco Springfield Co	1118	HALDER INC 821 W College Ave Waukesha Wisconsin 53186-5915 262-521-2050 • 262-521-3050 www.halder.com	5427	<i>Representatives:</i> Hermance Machinery 570-326-9156 • Williamsport Pennsylvania MSC Industrial Supply 800-645-7270 • Mellville New York Redmond Machinery 770-683-7297 • Palmetto Georgia	
H		HANGSTERFER'S LABORATORIES INC 175 Ogden Rd Mantua New Jersey 08051 856-468-0216 • 856-468-0200 www.hangsterfers.com	5632	HASCO AMERICA INC. 270 Rutledge Road, Unit B Fletcher North Carolina 28732-9399 877-427-2662 • 828-684-7960 www.hasco.com	5010
H & R See Cutler Industrial Sales	5469	HANNSA PRECISION 46 Hwan-Gong Rd Yung-Kang Ind District Tainan Tainan (City) 710 Taiwan 886-6-2335611 www.hannsa.tw	1027		
HAAS FACTORY OUTLET - TRIDENT 651 Day Hill Rd Windsor Connecticut 06095-1798 860-687-2466 • 860-687-2477 www.hfotrident.com	1218				

XSYTIN[®]-1

Take your aerospace machining to new heights.

Elevate your productivity and experience
 outstanding predictability with XSYTIN[®]-1,
 a revolutionary phase-toughened
 ceramic insert grade.



18695 Greenleaf Drive, PO Box 1040, Saegertown, PA 16433-1040
 www.greenleafcorporation.com | www.greenleafglobalsupport.com

For more information, visit www.greenleafcorporation.com/xsytin-1.

See us at Booth #5317

HASSAY SAVAGE CO
 15 Merrigan Way
 South Deerfield Massachusetts 01373
 413-863-9371 • 413-773-8430
 www.hassay-savage.com

5774

Representatives:
 BlackHawk Industrial
 413-455-3868 • Agawam Massachusetts
 DXP/ Kenneth Crosby
 508-497-0048 • Hopkington Massachusetts
 Cheshire Tool Company
 203-272-2947 • Cheshire Connecticut

HAWKEYE INNOVATION LLC 5838

720 Silver St
 Agawam Massachusetts 01001-2907
 413-233-1865 • 413-789-7736
 www.hawkeyeinnovation.com

HAYDEN CORP 5827

333 River St
 W Springfield Massachusetts 01089-3603
 413-734-4981 • 413-785-5052
 www.haydencorp.com

HEAVY DUTY FLOORS 3323

1 Hartford Square M/S 13W
 New Britain Connecticut 06052
 860-436-4556 • 860-436-3997
 www.heavydutyfloors.com

HEIDENHAIN CORP 1634

333 E State Pkwy
 Schaumburg Illinois 60173-5337
 847-490-1191 • 847-490-3931
 www.heidenhain.us

HEIMATEC GMBH 5146

See Platinum Tooling

HELMEL ENGINEERING PRODUCTS INC 3207

6520 Lockport Rd
 Niagara Falls New York 14305-3512
 716-297-8644 • 716-297-9405
 www.helmel.com

HEM INC 2038

PO Box 1148
 Pryor Oklahoma 74362-1148
 918-824-6252 • 918-825-4824
 www.hemsaw.com

HENNINGER 5146

See Platinum Tooling

HERMANN SCHMIDT CO 1723

26 Sea Pave Rd
 South Windsor Connecticut 06074
 860-289-3347 • 860-289-4846
 www.hschmidt.com

HEULE PRECISION TOOLS 5385

131 Commerce Drive
 Loveland Ohio 45140
 513-860-9900 • 513-860-9992
 www.heuletool.com

HEXAGON MANUFACTURING INTELLIGENCE 3103

250 Circuit Dr
 N Kingstown Rhode Island 02852-7441
 800-274-9433 • 401-886-2727
 www.HexagonMI.com

HIGH QA, INC 341

1 Bethany Rd Ste 26
 Hazlet New Jersey 07730-1660
 888-727-1266 • 732-344-6129
 www.highqa.com

HIRSCHMANN ENGINEERING USA INC 1231

165 Commerce Dr Ste 104
 Schaumburg Illinois 60173-5331
 847-468-9700 • 847-468-9701
 www.hirschmannusa.com

HIWIN CORPORATION 3034

12455 Jim Dhamer Dr
 Huntley Illinois 60124
 847-827-2270 • 847-827-2291
 www.hiwin.com



Your Eye Inside®

Fast, reliable metal machining & EDM inspection with Hawkeye® Rigid Borescopes

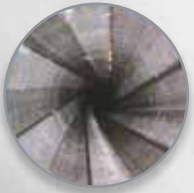

Rifle barrel seen with a Hawkeye Pro Slim 17"



Diesel injector with a Hawkeye Pro Hardy 7"



Burr in a cross hole viewed with a Hawkeye Pro Slim 7"

Visit us at:



Booth #3219 • W Springfield May 14 - 16, 2019

Bring Your Parts to the Show for Inspection Solutions!





Gradient Lens Corporation® gradientlens.com 800.536.0790 **Made in USA**



HEIDENHAIN



Enabling Machine Tool Control Technology

HEIDENHAIN and **ACU-RITE**: bridging the gap between easy-to-use CNC retrofit systems for knee mills and bed mills to the ultimate in 5-axis control technology.

eastec[®]

Stop at **Booth #1634**
and take them for a
test drive.

HEIDENHAIN CORPORATION, 333 East State Parkway, Schaumburg IL, 60173 847-490-1191 www.heidenhain.us

HEIDENHAIN | ACU-RITE | AMO | ETEL

HOLTS PRECISION INC 3156, 5419
 400 Chapel Rd Ste 3A
 South Windsor Connecticut 06074-4159
 860-289-4243 • 860-289-4255
 www.holtsprecision.com

HORN USA INC
 320 Premier Ct Suite 205
 Franklin Tennessee 37067
 615-771-4100 • 615-771-4101
 www.hornusa.com

5353 HOUGHTON INTERNATIONAL INC 5560
 PO Box 930
 Valley Forge Pennsylvania 19482-0930
 800-666-4000
 www.houghtonintl.com

HP JET FUSION 3D 5036
 See Cimquest Inc

HPM TECHNOLOGIE GMBH 5765
 Paul-Lechler-Strasse 21
 Dettingen An Der Erms Reutlingen 72581
 Germany
 1-203-281-1266 • 1-203-248-9331
 www.hpstechnologie.de

Principals:
 Carbide Related Technologies, Inc.

Representatives:
 Carbide Related Technologies, Inc. (CRT)
 1-203-281-1266 • North Haven Connecticut

HUDSON BEARING 3338
 See W T Hight CO

HUDSON TOOL STEEL CORPORATION 5538
 14 Industrial Park
 Dover New Hampshire 03820-4390
 866-557-2874 • 866-997-2874
 www.hudsonsteel.com

HUOT MANUFACTURING 5469
 See Cutler Industrial Sales

HUOT MANUFACTURING 1118
 See Lindco Springfield Co

HURON MACHINE PRODUCTS 5000
 2640 N Powerline Rd Suite 201
 Pompano Beach Florida 33069
 954-587-4541 • 954-583-2354
 www.jawsandchucks.com

HYD-MECH GROUP LTD 2122
 PO Box 1659
 Woodstock Ontario N4S 0A9
 Canada
 519-537-2103 • 519-539-5126
 www.hydmec.com

HYDRO 5516
 See Admiral Metals

HYGRADE PRECISION TECHNOLOGIES 5566
 329 Cooke St
 Plainville Connecticut 06062-1448
 860-747-5773 • 860-747-3179
 www.hygrade.com

HYPERTHERM 5743
 See Rock Ridge Abrasives

HPNEUMAT/COMMANDER/SNOW 5759
 See Automation Engineering Co

HIRSCHMANN

- ROTARY SPINDLES
- INDEXING TABLES
- REFERENCE SYSTEMS

A STRONG CONNECTION



Clamping Systems and Indexing Tables with one or more axes and Rotary Spindles coupled with high-precision fixture elements:
 A strong connection for innovative production processes in EDM, milling, measuring and laser machining technology.

Visit us at Eastec, Booth 1231

HIRSCHMANN ENGINEERING USA, INC.
 165 Commerce Dr. Ste 104 Schaumburg, IL 60173-5331
 www.hirschmannusa.com

IAI 3301
 See Minuteman / Empire Automation Systems

ICC / ZURN OIL 5570
 See Turpin Sales & Marketing Inc

IDEC 5858
 See The Hope Group

IGUS INC 257 Ferris Ave East Providence Rhode Island 02916 401-438-2200 • 401-438-7270 www.igus.com	5852
IMS USA LLC 110 Portwatch Way Ste 103 Wilmington North Carolina 28412-7008 910-796-2040 • 910-796-2039 www.imsusanc.com	5727
INFRANOR See CPU Automation Inc	3145
INIRAM PRECISION MACHINE TOOL INC 333 North Main Street 5 Axis Technology Center Middleton Massachusetts 01949 978-854-3037 www.iniram.com	1468
INNOVMETRIC SOFTWARE INC 2014 Cyrille-Duquet Bureau 310 QuÉbec Quebec G1N 4N6 Canada 418-688-2061 • 418-688-3001 www.innovmetric.com	3244
INSPECTIONXPRT CORPORATION PO Box 1660 Apex North Carolina 27502-3660 800-379-0322 • 800-379-0322	5865
INTER-LAKES BASES, INC. See Automation Engineering Co	5759
INTERNAL TOOL 1813 Yeager Ave La Verne California 91750-5232 909-392-4700 www.internaltool.com	5853
IRONCLAD MACHINERY LLC. 325 Belknap Mountain Rd Gilford New Hampshire 03249-6822 844-900-4766 www.ironcladmachinery.com	1064
ISWISS CORPORATION 161 Sanrico Dr Manchester Connecticut 06042-2224 860-327-4200 • 860-327-4141 iswisstools.com	5616
ITACA See Quality Vision International	3003
ITEM AMERICA See Northfield Precision Instrument Corp	5508
ITEM NORTHEAST 12105 Insurance Way Hagerstown Maryland 21740-5176 800-281-7939 • 301-665-9772 www.item24us.com	1861
J	
J & L METROLOGY INC 280 Clinton St Springfield Vermont 05156-3308 802-885-7100 • 802-885-2404 www.JLmetrology.com	3255

J&S MACHINE INC W6009 490th Ave Ellsworth Wisconsin 54011-5235 715-273-3376 • 715-273-5241 www.jsmachine.com	5820
---	-------------

Principals:
Clomea / 3C
Garboli
Simasv
YLM

Eastec Booth no. 1034

TOYODA

**100 HORSEPOWER
HIGH TORQUE
230 DEGREE
SWIVEL RANGE
FIVE AXIS HMC**

FH630SX-i 5-Axis HORIZONTAL MACHINING CENTER

Developed best-in-class 5-axis machine, the FH630SX-i 5-axis is designed with a tilting spindle with a robust C-axis drive train and an enlarged C-axis swivel range for wider complex part machining.

www.toyoda.com/5-axis

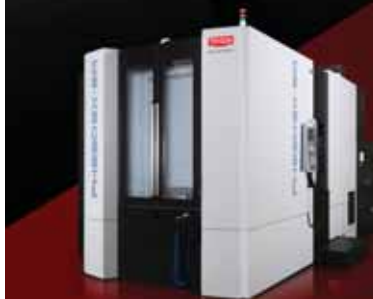

JAPAN MACHINE TOOLS CORP 10171 Olga Ln Houston Texas 77041-6122 713-939-7263 • 713-939-8229	1052	JINAN BODOR CNC MACHINE CO LTD 1146 No 1299 Xinluo Street Jinan City Shandong Province 250101 China 86(531)88690051 • 86(531)88690199 www.bodor.com	JORGENSEN CONVEYORS, INC. 5759 See Automation Engineering Co
JARVIS CASTER See W T Hight CO	3338	JM PERFORMANCE PRODUCTS INC 5422 1234 High St Fairport Hbr Ohio 44077-5558 440-357-1234 • 440-357-1129 www.jmperformanceproducts.com	JRI/JENFAB WASH SYSTEMS 5509 See Blast & Wash Systems
JAYCO CLEANING TECHNOLOGIES 5832 8812 Beckett Rd West Chester Ohio 45069-2902 513-737-9600 www.jaycoclean.com		JENSEN FABRICATING 5440 See Mikro Industrial Finishing Co	JUDGE TOOL & GAGE 3138 555 Lordship Blvd Unit A Stratford Connecticut 06615-7156 203-378-8848 • 203-377-1619 www.judgetool.com
JERGENS INC 5644 15700 S Waterloo Rd Cleveland Ohio 44110-3898 877-486-1454 • 216-481-6193 www.jergensinc.com		JMD INDUSTRIES INC 5536 1 Park Ave Hudson New Hampshire 03051-3928 603-882-3198 www.jmdindustries.com	K
JET EDGE 1770 12070 43rd St NE Saint Michael Minnesota 55376-8427 763-497-8700 • 763-497-8704 www.jetedge.com		JOHNSON GAGE CO 3042 534 Cottage Grove Rd Bloomfield Connecticut 06002-3093 860-242-5541 • 860-242-0513 www.johnsongage.com	KAAST MACHINE TOOLS INC 2134 3 Merion Terrace Aldan Pennsylvania 19018 224-216-8886 www.kaast-usa.com
JH ROBOTICS INC 1462 109 Main Street Johnson City New York 13790-2482 607-729-3758 • 607-797-6941 www.jhrobotics.com			KAISER ALUMINUM 5516 See Admiral Metals
			KALOW TECHNOLOGIES 5821 238 Innovation Dr N Clarendon Vermont 05759-9387 802-775-4633 • 802-747-3249 www.kalowtech.com
			KASTO INC 1661 3002 Venture Ct Export Pennsylvania 15632-8949 724-325-5600 • 724-325-5611 www.kasto.com/us

BETTER. FASTER. STRONGER.

TSUDAKOMA BALL DRIVE

Stop wasting time with products that slow you down. Never compromise accuracy again with Tsudakoma Rotary Tables. Built for speed and designed for ultimate precision, our rotary tables diminish user error and amplify productivity. Our Integration department will take care of all installations on-site, so you can start increasing production immediately. Let Koma bring your shop up to speed today.

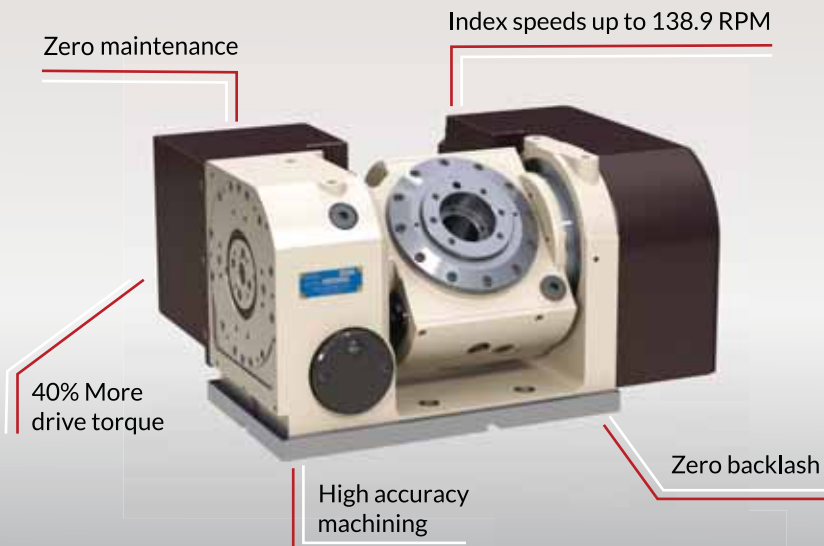

KP
KOMA PRECISION

www.komaprecision.com

eastec

Visit us at Eastec!
May 14th-16th

BOOTH 5359

KAYS ENGINEERING / DEHOFF / ELDORADO 1612
 900 Industrial Dr
 Marshall Missouri 65340
 660-886-9929 • 660-886-2249
 www.kays-dehoff.com

KELLER PRODUCTS INC 3057
 180 Middlesex St A Division of Plastic Design
 N Chelmsford Massachusetts 01863
 800-352-8422 • 978-264-0221
 www.kellerfilters.com

KENNAMETAL 5563
 See BlackHawk / Kennametal

KENT SURFACE & ROTARY GRINDERS 1662
 See Kgk International Corp

KETCHAM & CO INC 3306
 PO Box 156
 New Canaan Connecticut 06840-0156
 203-322-6667
 www.ketchaminc.com

KEYENCE CORP OF AMERICA 3029,2042
 500 Park Blvd Suite 200
 Itasca Illinois 60143-3111
 888-539-3623 • 201-930-1883
 www.keyence.com

KGK INTERNATIONAL CORP 1662
 900 A River St
 Windsor Connecticut 06095-1330
 860-219-1550 • 860-219-0518
 www.kgki.com

Principals:
 Kent Surface & Rotary Grinders
 Mandelli 5 Axis Machining Centers
 Ohtori 5 Axis Machining Centers
 Seibu Wire EDMs
 Toshiba Boring Mills

KITAGAWA-NORTHTECH INC. 1152
 301 Commerce Dr
 Schaumburg Illinois 60173-5305
 847-310-8787 • 847-310-9484
 www.kitagawa.us

KIWA 2034
 See Methods Machine Tools Inc

KME 5516
 See Admiral Metals

KMT WATERJET SYSTEMS INC 1344
 635 W 12th St
 Baxter Springs Kansas 66713-1940
 800-826-9274 • 620-856-5050
 www.kmtwaterjet.com

KOLVER 5619
 8 Industrial Way Unit 1
 Salem New Hampshire 03079-4873
 603-912-5886 • 978-923-8522
 www.kolverusa.com/home

KOMA PRECISION INC 5359
 20 Thompson Rd
 East Windsor Connecticut 06088
 860-627-7059 • 860-623-4132
 www.komaprecision.com

Representatives:
 860 627-7059 • East Windsor Connecticut

KOTEM 3003
 See Quality Vision International

KSI SWISS 1640
 1320 Larc Industrial Blvd
 Burnsville Minnesota 55337-1412
 952-564-3290 • 952-564-3294

KURAKI AMERICA 1022
 See American Systems & Equipment Corp

KYOCERA PRECISION TOOLS INC 5573
 102 Industrial Park Rd
 Hendersonville North Carolina 28792-9011
 800-823-7284 • 828-692-1344
 www.kyoceraprecisiontools.com

<p>KYZEN CORPORATION 3027 430 Harding Industrial Dr Nashville Tennessee 37211-3106 615-983-4562 • 615-831-0889 www.kyzen.com</p>		<p>LANG TECHNOVATION CO 5483 1020 James Dr Suite I Hartland Wisconsin 53029-8305 262-446-9850 • 262-446-9851 www.lang-technovation.com</p> <p><i>Representatives:</i> Industrial Tool Supply 978-970-3600 • Lowell Massachusetts</p>	<p>LASERSTAR TECHNOLOGIES CORP 2100 1 Industrial Ct Riverside Rhode Island 02915-5218 401-438-1500 • 866-516-3043 www.laserstar.net</p>
L			
<p>L.F.O'LEARY CO.INC/ GLASTONBURY SOUTHERN GAGE 3254 775 Pleasant St Ste 13 East Weymouth Massachusetts 02189-2355 781-331-3913 www.lfolearyinc.com</p> <p><i>Principals:</i> Fowler High Precision Glastonbury Southern Gage Mitutoyo CMM Vision Oasis Inspection System Phillips Precision Inspection Arsenal Vision Engineering</p> <p><i>Representatives:</i> Glastonbury Southern Gage 781-331-3450 • Weymouth Massachusetts</p>		<p>LAROCHE FOUNDRY LTD 5362 19 Rue De Chantal Pont-Rouge Quebec G3H 3M4 Canada 418-873-2516 • 418-873-4669 www.larochefoundry.com</p>	<p>LEXINGTON CUTTER 5469 See Cutler Industrial Sales</p>
<p>LAMOTHERMIC CORP 5614 391 Route 312 Brewster New York 10509-2328 845-278-6118 • 845-279-3716 www.lamothermic.com</p>		<p>LASER MARKING TECHNOLOGIES LLC 2029 1101 W Sanilac Rd Caro Michigan 48723-9539 866-799-0199 • 989-673-1655 www.lasermarktech.com</p> <p><i>Representatives:</i> Perseo Erie 800.900.9117 • Erie Pennsylvania</p>	<p>LIBERTY PACKAGING CO 3227 22 Raleigh Rd Braintree Massachusetts 02184-4926 781-849-3355 • 781-848-6760 www.libertyintercept.com</p>
		<p>LASER MEASURING TECHNOLOGIES LLC 3122 858-1 Business Park Dr Traverse City Michigan 49686 231-642-5664 www.toolmeasuring.com</p>	<p>LILLYWORKS SCHEDULING & ERP SOFTWARE 5763 One Liberty Lane Suite 210 Hampton New Hampshire 03842 603-926-9696 www.protectedflowmanufacturing.com</p>



LANG TECHNOVATION
simple. gripping. future.

grip the future ■

Innovative workholding and automation systems for the machining industry

eastec®
MAY 14-16, 2019
WEST SPRINGFIELD, MA

Please visit us at Booth #5483

lang-technovation.com

LINDCO SPRINGFIELD CO 1118
 176 Wayside Ave
 W Springfield Massachusetts 01089-1318
 413-737-3577 • 413-737-0159
 www.lindcospringfield.com

Principals:
 Blaser-Swisslube
 Ceratizit
 GWS/Benchmark Carbide
 Haimer
 Huot Manufacturing
 Magido USA
 Radiac Abrasives
 Sandvik Coromant
 YG-1

LINK INDUSTRIES 5826
 2208 S Straits Hwy
 Indian River Michigan 49749
 231-238-9012 • 231-238-7202
 www.linkcuttingtools.com

LK METROLOGY INC 3310
 12701 Grand River Rd
 Brighton Michigan 48116-8506
 810-263-6100
 www.lkmetrology.com

LMI 3328
 See Axis New England

LMT ONSRUD TOOLING 1035
 See Multicam East

LOVEJOY TOOL CO 5242
 133 Main St PO Box 949
 Springfield Vermont 05156-3509
 802-885-2194 • 802-885-9511
 www.lovejoytool.com

LS INDUSTRIES INC 3043
 710 E 17th St N
 Wichita Kansas 67214-1312
 316-265-7997 • 316-265-0013
 www.lsindustries.com

LUBRICATION TECHNOLOGIES INC 5737
 120 Bosworth St
 W Springfield Massachusetts 01089-3503
 413-788-5823 • 413-788-5743
 www.lubetechnologies.com

LUCIFER FURNACES INC 2003
 2048 Bunnell Rd
 Warrington Pennsylvania 18976-2497
 215-343-0411
 www.luciferfurnaces.com

LYNDEX-NIKKEN INC 5533
 1468 Armour Blvd
 Mundelein Illinois 60060-4404
 847-367-4800 • 847-367-4815
 www.lyndexnikken.com

LYNN WELDING 2027
 75 Rockwell Rd Ste 1
 Newington Connecticut 06111-5564
 860-667-4400 • 860-667-3040
 www.lynnwelding.com

M

MA FORD 5570
 See Turpin Sales & Marketing Inc

MACDAC ENGINEERING 5233
 27 QUALITY Avenue
 Somers Connecticut 06071-1840
 860-870-5544 • 860-749-5373
 www.macdac.com

Principals:
 Dassault Systemes
 Excellerant
 Mastercam
 WireFreeCNC

Marposs offers the broadest range of products for all types of measurement and inspection across a variety of industries. This ensures you get exactly the right level of technology, flexibility and cost you require for your application. Our solution portfolio breadth is matched by extensive industry experience, enabling us to serve as a single source for more of your quality and process control needs .



eastec BOOTH #1644

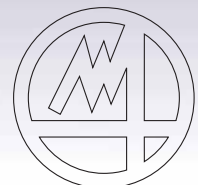

MARPOSS
 www.marposs.com

MACH 1 SYSTEMS INC
 27 Tozer Rd
 Beverly Massachusetts 01915-5513
 978-922-0268 • 978-921-0208
 www.mach-1tooling.com

1725

MACHINOMETRICS
 47 Pleasant Street Suite 2-S
 Northampton Massachusetts 01060
 413-341-5747
 www.machinometrics.com

5037

MACHITECH AUTOMATION
 See Airgas

1656

MAGIDO USA
 261 Tiger Way
 Peachtree City Georgia 30269-1680
 844-462-4436

1838

MAGIDO USA
 See Lindco Springfield Co

1118

MAGLINER
 See W T Hight Co

3338

MAGNUS PRECISION MFG INC.
 1912 State Route 96
 Phelps New York 14532-9705
 315-548-8032 • 315-548-8041

5862

MAKINO INC
 7680 Innovation Way
 Mason Ohio 45040-9695
 513-573-7200 • 513-573-7360
 www.makino.com

1236

**MANDELLI 5 AXIS
 MACHINING CENTERS**
 See Kgc International Corp

1662

MANUFACTURING NEWS
 1133 Airline Drive
 Grapevine Texas 76051
 800-375-8488 • 817-488-7813
 www.mfgnewsweb.com

5864

MAPAL INC
 4032 Dove Road
 Port Huron Michigan 48060-7442
 810-364-8020 • 810-364-4750
 www.mapal.com

5327

**MARKSMAN BY MILLENNIUM
 SIGNATURES MARKING SYSTEMS INC** 3305
 941 E Lovejoy St
 Buffalo New York 14206-1032
 905-639-0909

Representatives:
 IMG - Electromark
 315-735-7591 • Utica New York
 Dixie Tool Company
 956-544-4333 • Brownsville Texas

MARPOSS CORP
 3300 Cross Creek Pkwy
 Auburn Hills Michigan 48326-2758
 248-370-0404 • 248-370-0621
 www.marposs.com

1644

Representatives:
 Alliance Sensors Group
 856-727-0250 • Moorestown New Jersey
 Blackhawk Industrial
 860-986-7177 • Hartford Connecticut
 Salem Tools
 800-390-4348 • Salem Virginia

MARTINDALE ELECTRIC CO
 1375 Hird Ave
 Cleveland Ohio 44107-3008
 216-521-8567 • 216-521-9476
 www.martindaleco.com

5719

MARUBENI CITIZEN CINCOM 1406
 68 Moylan Lane
 Agawam Massachusetts 01001-0366
 413-786-6655 • 413-786-9334
 www.marucit.com

MASS FINISHING INC.
 See Mikro Industrial Finishing Co

5440

MASTERCAM
 See Cimquest Inc

5036

**OUR TOOLPATHS
 SAVE TOOLS**

**DYNAMIC MOTION TOOLPATHS EVENLY
 DISTRIBUTE HEAT AND FORCE**

Dramatically extend the life of tools and give new life to older machines on your floor with Mastercam's Dynamic toolpaths. Milling even tough materials like titanium and Inconel is faster and smoother the Dynamic way. Save tools. Save time. Save money. Use Mastercam Dynamic toolpaths.

Mastercam® 2020 COMING SOON

www.mastercam.com

sme Corporate Member

**MASTERCAM/
CNC SOFTWARE INC** 5249
671 Old Post Rd
Tolland Connecticut 06084
860-875-5006 • 860-872-1565
www.mastercam.com

MASTERCAM 5233
See Macdac Engineering

MATERION 5516
See Admiral Metals

MATTERHACKERS 5848
27156 Burbank
Foothill Rnch California 92610-2503
949-613-5838
www.matterhackers.com

MAXTOOL CORP. 5002
37 Brundige Dr
Goldens Bridge New York 10526-1413
315-629-8665
www.mymaxtool.com

MAYFRAN 5469
See Cutler Industrial Sales

MB METAL TECHNOLOGIES LLC 2009
403 S Hawley Rd
Milwaukee Wisconsin 53214-1906
855-897-1439 • 414-771-9043
www.markinbox.com

MCOR TECHNOLOGIES 5036
See Cimquest Inc

MCRL INC / FLUID CHILLERS 1001
162 Industrial Blvd Ste 2A
Hanson Massachusetts 02341
844-627-5911 • 844-333-0729
www.mcrlinc.com

Principals:
Fluid Chillers

Representatives:
Fluid Chillers
517-484-9190 • Lansing Michigan

MEDCASTER 3338
See W T Hight CO

MELIN TOOL COMPANY 5618
5565 Venture Dr Ste C
Cleveland Ohio 44130-9302
216-362-4200 • 216-362-4230

METALLURGICAL PROCESSING INC 5724
68 Arthur St
New Britain Connecticut 06053-3902
860-224-2648 • 860-225-0178
www.mpimetaltreating.com

METALMIZER 1814
8180 W 10th St
Indianapolis Indiana 46214-2430
800-552-5097 • 317-273-1011
www.metalmizer.com

**METHODS MACHINE
TOOLS INC** 2034
65 Union Ave
Sudbury Massachusetts 01776-2277
978-639-5388 • 978-443-7466
www.methodsmachine.com

Principals:
Fanuc
Fanuc Robotics
Kiwa
Nakamura-Tome
Niigata
Ocean Technologies
VisionGauge
Yasda





Machine Monitoring at Your Fingertips



Peace of mind anywhere, anytime.

Mitsubishi Electric proudly presents the IMA Mobile App. Our IMA Mobile App is an MTConnect complaint application, which works in conjunction with our IMA Adapter and any other controls that use MTConnect. The IMA Mobile app gives you real-time data of your machine shop to ensure you're running at optimal levels. Whether you're in the shop or on the go, our IMA Mobile App is here to provide you peace of mind 24/7.

For the fastest part processing, best finishes, and IIoT capability, always choose Mitsubishi Electric CNCs.

Automation Simplified.





eastec[®]
Come visit us at Eastec
BOOTH 1140

us.MitsubishiElectric.com/fa/en/support/services/ima

METROLOGIC GROUP SERVICES 28064 Center Oaks Ct Wixom Michigan 48393-3353 248-504-6200 • 248-504-5430 www.metrologicgroup.com	3228	Monroe Connecticut 06468-1174 203-261-3100 • 203-268-4752 www.mikrontool.com	Twinsburg Ohio 44087-2376 800-843-3904 • 330-963-6762 www.mirka.com
METRORON INC 28064 Center Oaks Court Suite 200 Wixom Michigan 48393 815-381-0920 • 815-381-0921 www.metronor.com	3127	MILLER ELECTRIC See Airgas	<i>Principals:</i> CAFRO Bonded Abrasives Mirka Abrasives
MIDACO CORP 2000 Touhy Ave Elk Grove Vlg Illinois 60007-5368 847-593-8420 • 847-593-8451 www.midaco-corp.com	1858	MILLINOCKET FABRICATION & MACHINE LLC 432 Katahdin Ave Millinocket Maine 04462-1624 207-723-9733 • 207-723-9735 www.millinocketfab.com	MIRKA ABRASIVES 1711 See Mirka / Cafro
MIDWEST AUTOMATION See Northeast Machinery Sales/FlexCNC	1228	MINUTEMAN / EMPIRE AUTOMATION SYSTEMS 7 Foster St Wakefield Massachusetts 01880-2903 781-245-9550 • 781-246-4982 www.maseas.com	MITEE-BITE PRODUCTS LLC 5459 340 Route 16B PO Box 430 Center Ossipee New Hampshire 03814-0430 603-539-4538 • 603-539-2183 www.miteebite.com
MIKRO INDUSTRIAL FINISHING CO 170 W Main St Vernon Connecticut 06066-3503 860-875-6357 • 860-871-6461 www.mikroi.com	5440	<i>Principals:</i> ABB Baumer Emerson ASCO & Aventics IAI Mobile Industrial Robots Pick-it Schmalz Schunk Soft Robotics Technifor	MITSUBISHI EDM / MC MACHINERY SYSTEMS INC 1426 85 Northwest Point Blvd. Elk Grove Illinois 60007 630-616-5920 • 630-616-4068 www.mcmachinery.com
<i>Principals:</i> Baron-Blakeslee CLM Vibetech Jensen Fabricating Mass Finishing Inc.		MIRKA / CAFRO 1711 2375 Edison Blvd	MITSUBISHI ELECTRIC AUTOMATION INC 1140 500 Corporate Woods Pkwy Vernon Hills Illinois 60061-3108 847-478-2500 • 847-478-2253 www.us.mitsubishielectric.com/fa/en
MIKRON CORP MONROE 200 Main Street Unit 2A	5426		

Precision Collet Chucks

Northfield... the Leader in Precision Reliability & Productivity.



Precision At Any Speed!

Our line of superior Collet Chucks available in 5C, 16C & 3J varieties offers:

- Exclusive "Dead Stop" centers ensuring perfect 'Z' axis location
- Parts are gripped for more rigidity banking on a solid stop
- Available with a coolant/air passage for Air Detect part seat sensing, ejection, chip blow out and coolant from back of work piece

Call us or visit our website today for more information on diaphragm, sliding jaw air chucks and special chucks for your unique application requirements.



NORTHFIELD

Precision Instrument Corp.
4400 Austin Blvd. Island Park, NY 11558
northfield.com • tel: 561.431.1112

Visit Us at EASTEC!
Booth #5508

MITSUBISHI MATERIALS USA 11250 Slater Ave Fountain Vly California 92708-5421 980-312-3100 • 714-352-6141 www.mmus-carbide.com	5468
MITSUI SEIKI USA See Ross Machinery Sales Inc	1620
MITUTOYO See Mitutoyo America Corp	3111
MITUTOYO CMM VISION SURFACE FINISH SPC FORM See L.F.O'leary Co.Inc/ Glastonbury Southern Gage	3254
MITUTOYO AMERICA CORP 965 Corporate Blvd Aurora Illinois 60502-9102 630-820-9666 • 630-978-5394 www.mitutoyo.com	3111
<i>Principals:</i> Mitutoyo	
MOBILE INDUSTRIAL ROBOTS See Minuteman / Empire Automation Systems	3301
MODERN INDUSTRIES INC 613 W 11th St Erie Pennsylvania 16501-1503 814-455-8061 • 814-453-4382 www.modernind.com	5750
MODERN MACHINE SHOP 6915 Valley Ln Cincinnati Ohio 45244-3153 513-527-8800 • 513-527-8801 www.gardnerweb.com	5746
MODERN TOOLS INC PO Box 2996 Woburn Massachusetts 02180-2821 781-438-3211 • 781-438-3147 www.moderntools.com	1127
MODULA INC 90 Alfred A Plourde Pkwy Lewiston Maine 04240 207-440-5100 • 877-648-9755 www.modula.us	1254
MONODE 9200 Tyler Blvd Mentor Ohio 44060-1882 419-929-3501 • 419-929-8806 www.monode.com	5682
MONSTER TOOL CO INC PO Box 1749 San Marcos California 92079 760-477-1000 • 888-363-6455 www.monstertool.com	5411
MOXA See Axis New England	3328
MP SYSTEMS 34 Bradley Park Rd East Granby Connecticut 06026-9789 877-689-1860 www.mp-systems.net	5368
MSC FILTRATION TECHNOLOGIES See Eclipse Magnetics	3022
MUELLER BRASS See Admiral Metals	5516

MULTICAM EAST 707 N Howard St Baltimore Maryland 21201-4608 410-728-6000 • 410-728-4822 www.multicam.com	1035
---	------

Principals:
LMT Onsrud Tooling
Pinnacle Systems

NAGEL PRECISION INC 288 Dino Dr Ann Arbor Michigan 48103-9502 734-426-5650 • 734-426-5649 www.nagelusa.com	5850
---	------

NAKAMURA-TOME See Methods Machine Tools Inc	2034
---	------

N

SERIES HES

Electric Spindles for Machining Centers

HES510: 50,000 RPM MAX
HES810: 80,000 RPM MAX

ULTRA HIGH SPEED & SUPER PRECISION

- Transforms CNC Machines into High Speed Machining Centers
- Ultra-Precision Ceramic Bearings for High Speed Performance
- Integral Motor and Spindle Construction
- Emergency Break-Away Connector
- Air-Cooling System
- Small Diameter Drilling and Milling
- Large Variety of Tapers Available

BT NT IT HSK A

NSK AMERICA CORPORATION

www.NSKAmericaCorp.com
1800 Global Parkway, Hoffman Estates, IL 60192
Phone: (847) 843-7664 | Toll Free: (800) 585-4675 | Fax: (847) 843-7622
info@nskamericacorp.com

See us at Booth #5344

NANSHAN See Admiral Metals	5516	www.newenglandsales.com	NIKON METROLOGY INC 3203 12701 Grand River Rd Brighton Michigan 48116-8506 810-220-4360 • 810-220-4300 www.nikonmetrology.com
NCSIMUL HEXAGON MANUFACTURING INTELLIGENCE 5358 50 Milk Street 16th Fl Boston Massachusetts 02109 617-401-2197 • 815-425-2197 www.ncsimul.com		NEW SCALE ROBOTICS 2139 121 Victor Heights Pkwy Victor New York 14564-8938 585-924-4450 • 585-924-4468 www.newsclerobotics.com	NITCO INDUSTRIAL CLEANING EQUIPMENT & COMMERCIAL PRODUCTS 3002 230 Cherry St Shrewsbury Massachusetts 01545 508-842-4404 www.nitco-lift.com
NESSTEEL INC 5033 83 Gerber Dr Tolland Connecticut 06084-2851 860-875-2900 • 860-875-4900 www.nessteel.com		NEXAS AMERICA LLC 5527 P.O. Box 152 Hampden Massachusetts 01036 413-566-0100 www.nexasamerica.com	NOBLE INDUSTRIAL FURNACE 3354 40 Woolam Rd East Windsor Connecticut 06088-9707 860-623-9256 • 860-627-8414 www.noblefurnace.com
NEW ENGLAND METAL FINISHING & PRECISION FINISHING SERVICES 5136 60 Ezra Silva Ln Windsor Connecticut 06095-2122 860-640-4600 • 860-640-4606 www.nemfi.com		<i>Principals:</i> Predator Software Scytec Consulting Inc.	NORDFAB DUCTING 3025 150 Transit Avenue Thomasville North Carolina 27361 336-821-0801 www.nordfab.com
NEW ENGLAND MINIATURE BALL 5364 163 Greenwoods Rd W PO Box 585 Norfolk Connecticut 06058 860-542-5543 • 860-542-5058 www.nemb.com		NEXGEN TOOLING 5747 42 Railroad Ave Springvale Maine 04083-1241 207-850-1073 www.nexgentooling.com	NORTH AMERICAN STAINLESS 5516 See Admiral Metals
NEW ENGLAND SALES INC 2026 55 Corporate Park Dr Pembroke Massachusetts 02359-1966 781-826-8855 • 781-826-2390		NIIGATA 2034 See Methods Machine Tools Inc	NORTH COAST TECHNICAL 1865 8761 Mayfield Rd Ste 302 Chesterland Ohio 44026-2600 440-729-7540 • 440-729-7546 www.nctechs.com

hyperMILL®
Perfect. Precise. Programming.

CAM? Still satisfied?
Explore the benefits of *hyperMILL®* and switch to the CAM solution for all of your 2.5D, 3D, 5-axis, mill-turn, HSC and HPC requirements.

25 YEARS OPEN MIND

EASTEC
W. Springfield
MAY 14-16
Booth 5228

© This item was programmed and produced by CAD/CAM

OPEN MIND
THE CAM FORCE

We push machining to the limit

www.openmind-tech.com

NORTHEAST COATING TECHNOLOGIES 5540 105 York St Kennebunk Maine 04043-7104 207-985-3232 • 207-985-4416 www.northeastcoating.com
NORTHEAST MACHINERY SALES/FLEXCNC 1228 6332 Flank Dr Harrisburg Pennsylvania 17112-2779 717-541-1633 • 717-541-8014 www.midatlanticmachinery.com
<i>Principals:</i> FlexCNC Midwest Automation Pat Mooney Inc.
NORTHFIELD PRECISION INSTRUMENT CORP 5508 4400 Austin Blvd PO Box 550 Island Park New York 11558-1621 516-431-1112 • 516-431-1928 www.northfield.com
<i>Principals:</i> Item America
<i>Representatives:</i> Drowne Machinery Associates 781-237-0402 or 508-330-0252 • Wellesley MA Ultra Precision Components 248-318-5587 • Fenton Michigan Nichols Associates 574-534-5661 • Goshen Indiana
NORTHLAND TOOL & ELECTRONICS 5828 117 Gould Rd Weare New Hampshire 03281-5956 800-774-6353 • 603-529-3019 www.northlandtool.com

NSF INTERNATIONAL STRATEGIC REGISTRATIONS 789 N Dixboro Rd Ann Arbor Michigan 48105-9723 734-827-3804 • 734-769-0109 www.nsf-isr.org	2141	OKAMOTO CORP 425 D Hayden Station Rd Windsor Connecticut 06095 860-219-1006 • 860-219-1007 www.okamotocorp.com	1044	PALETTI USA 145 Keystone Dr Montgomeryville Pennsylvania 18936-9638 267-289-0020 • 267-289-0023 www.pallettiusa.com	3239
NSK AMERICA CORP 1800 Global Pkwy Hoffman Est Illinois 60192-1578 847-843-7664 • 847-843-7622 www.nskamericacorp.com	5344	OLYMPUS AMERICA INC 48 Woerd Avenue Waltham Massachusetts 02453-3824 781-419-3900 • 781-419-3980 www.olympus-ims.com	1766	PAPERLESS PARTS 133 Portland Boston Massachusetts 02114 617-475-0161 www.paperlessparts.com	5667
NTK CUTTING TOOLS 46929 Magellan Dr Wixom Michigan 48393-3699 248-668-0100 • 248-668-0200 www.ntkcuttingtools.com	5564	OMAX CORP 21409 72nd Ave S Kent Washington 98032-1944 253-872-2300 • 253-872-6190 www.omax.com	1106	PARKER See The Hope Group	5858
NTMA 1357 Rockside Road Cleveland Ohio 44134-2776 800-248-6862 • 216-264-2840 www.ntma.com	1862	OMEGA TMM INC. 101 Perinton Pkwy Fairport New York 14450-9104 844-396-5537 • 844-396-5537 www.omegatmm.com	5127	PARKER HANNIFIN See Axis New England	3328
NUMBERALL STAMP & TOOL CO 1 High St PO Box 187 Sangerville Maine 04479 207-876-3541 • 207-876-3566 www.numberall.com	1142	OMNI SERVICES 12 East Worcester Street Worcester Massachusetts 01604 508-799-2746 • 508-799-2844 www.omniseservices.com	5612	PAT MOONEY INC. See Northeast Machinery Sales/FlexCNC	1228
NYSUS SOLUTIONS LLC 403 Tomahawk Dr Maumee Ohio 43537-1633 877-830-8624 • 419-605-9814 www.nysus.com	3259	OMRON See Axis New England	3328	PAUWAY CORP 63 N Cherry St Ste 2 Wallingford Connecticut 06492-2363 203-265-3939 • 203-284-8766 www.pauwaycorp.com	5549
OASIS INSPECTION SYSTEM See L.F.O'leary Co.Inc/ Glastonbury Southern Gage	3254	OPEN MIND TECHNOLOGIES USA INC. 1492 Highland Ave Suite 3 Needham Massachusetts 02492-2606 339-225-4557 • 270-912-5822 www.openmind-tech.com	5228	PAWS WORKHOLDING 11533 Liberty St Clio Michigan 48420-1493 866-686-7297 • 810-686-2860 www.pawsworkholding.com	5866
OASIS INSPECTION SYSTEMS 110 Sleepy Hollow Dr Middletown Delaware 19709-8894 302-449-0199 • 302-449-0288 www.oasisinspectionsystems.com	3050	OPTICAL GAGING PRODUCTS See Quality Vision International	3003	PEARSE-BERTRAM LLC 22 Tobey Rd Bloomfield Connecticut 06002-3522 860-242-7777 • 860-242-2673 www.pearse-bertram.com	3245
OASIS SCIENTIFIC INC 3110 Wade Hampton Blvd Ste 18 Taylors South Carolina 29687-2863 864-469-0919 www.oasisscientific.com	320	OPTINOVA AMERICAS INC. 22 Shelter Rock Ln Unit 24 Danbury Connecticut 06810-8268 203-743-0908 • 203-912-3707 www.optinova.com	5772	PENN STAINLESS PRODUCTS INC 190 Kelly Rd Quakertown Pennsylvania 18951-4208 203-536-3053 www.pennstainless.com	5043
OC WHITE CO 4226 Church St Thorndike Massachusetts 01079 413-289-1751 • 413-289-1754 www.ocwhite.com	3051	ORIGIN TECHNOLOGIES CORP 9238 Madison Blvd Building 1 Suite 845 Madison Alabama 35758-9100 256-461-1313 • 256-461-1390 www.origintech.com	1854	PERRY TECHNOLOGY CORP 120 Industrial Park Rd New Hartford Connecticut 06057-0021 860-738-2525 • 860-738-2455 www.perrygear.com	5623
OCEAN TECHNOLOGIES See Methods Machine Tools Inc	2034	OSAAP AMERICA 10 Kidder Rd Ste 4 Chelmsford Massachusetts 01824-3375 978-390-2468 www.osaapamerica.com	1132	PETERSON STEEL CORP 61 West Mountain Street PO Box 60328 Worcester Massachusetts 01606-0328 508-853-3630 • 508-853-7485 www.petersonsteel.com	5558
OERLIKON BALZERS COATING USA INC 1471 E Woodfield Rd Ste 201 Schaumburg Illinois 60173-4968 847-619-5541 • 847-619-5653 www.oerlikon.com/balzers/us	5567	OSG USA INC 1945 West Walnut Hill Ln Irving Texas 75038 800-837-2223 • 800-837-3334 www.osgttool.com	5652	PHILLIPS PRECISION INSPECTION ARSENAL See L.F.O'leary Co.Inc/ Glastonbury Southern Gage	3254
OG BELL CO 139 Lear Rd Avon Lake Ohio 44012-1904 440-933-7797 • 440-933-6660 www.ogbell.com	5767	OUTOKUMPU See Admiral Metals	5516	PICK-IT See Minuteman / Empire Automation Systems	3301
OHTORI 5 AXIS MACHINING CENTERS See Kgc International Corp	1662	PACKARD MACHINERY CO INC 504 Groton Rd. Westford Massachusetts 01886-1151 978-692-3100 • 978-692-4192 www.packardmachinery.com	1742	PINNACLE SYSTEMS See Multicam East	1035
		P		PINPOINT LASER SYSTEMS 56 Pulaski St Unit 5 Peabody Massachusetts 01960-1830 978-532-8001 • 978-532-8002 www.pinpointlaser.com	3054

PLASTICS INTERNATIONAL 7600 Anagram Dr Eden Prairie Minnesota 55344-7309 952-934-2303 • 952-934-2314 www.plasticsintl.com	5366	PRECISION PUNCH CORP 304 Christian Ln Berlin Connecticut 06037-1420 860-229-9902 • 860-224-4238 www.ppunch.com	5633	R
PLATINUM TOOLING 16 East Piper Lane Suite 128 Prospect Heights Illinois 60070-1871 847-749-0633 • 847-749-2445 www.platinumtooling.com	5146	PRECO INC 500 Laser Dr Somerset Wisconsin 54025-9774 715-247-3285 • 715-247-5650 www.precoinc.com	5237	R & D TECHNOLOGIES 5776 70 Romano Vineyard Way Suite 114 North Kingstown Rhode Island 02852 401-885-6400 • 401-667-0213 www.rnd-tech.com
<i>Principals:</i> AMF heimatec GmbH Henninger Tecnicrafts		PREDATOR SOFTWARE See Nexas America LLC	5527	R&R FIXTURES LLC 3318 1809 Industrial Park Drive Grand Haven Michigan 49417-0161 616-847-6045 • 616-847-6082 www.rrfixtures.com
PLATIT US 1840 Industrial Dr Ste 220 Libertyville Illinois 60048-9412 847-680-5270 • 847-680-5271	5058	PRO ULTRASONICS PO Box 999 Nebo North Carolina 28761 828-584-1005 • 828-584-9005 www.proultrasonics.com	3055	RACER MACHINERY INTERNATIONAL INC 1638 1030 Fountain St N Cambridge Ontario N3H 4R7 Canada 519-623-6223 • 519-623-1122 www.racerinternational.com
POCKET NC COMPANY 119A Gold Miner Ln Belgrade Montana 59714 406-451-3799	5008	PRODUCTION METALS 17 Enterprise Dr Monroe Connecticut 06468-2662 203-709-1433 • 203-975-1405 www.productionmetals.com	1870	<i>Principals:</i> Standard Modern Lathes
POCO GRAPHITE 300 Old Greenwood Rd Decatur Texas 76234-3068 940-627-2121 • 940-393-8366 www.poco.com	1227	PROSHOP ERP 101 Prospect St Ste 203 Bellingham Washington 98225-4449 360-515-7576 www.ProShopERP.com	5847	<i>Representatives:</i> Vander Ziel Machinery +1-616-868-1111 • Alto Michigan Novi Precision Products Inc 810-227-1024 • Brighton Michigan
POLYRIX INC 2022 Rue Lavoisier App 220 Quebec Quebec G1N 4L5 Canada 418-210-0198 • 581-981-7395 www.polyrix.com	3129	PROTO LABS INC 5540 Pioneer Creek Dr Maple Plain Minnesota 55359-9003 763-479-3680 www.protolabs.com	5752	RADIAC ABRASIVES 1118 See Lindco Springfield Co
PRATT & WHITNEY MEASUREMENT SYSTEMS INC 66 Douglas St Bloomfield Connecticut 06002-3619 860-286-8181 • 860-286-7878 www.prattandwhitney.com	3006	PUREX INC 2246 Palmer Dr Ste 108 Schaumburg Illinois 60173-3852 847-348-5203 www.purexinc.com	2102	RADYNE CORP 1102 211 W Boden St Milwaukee Wisconsin 53207-6277 414-481-8360 • 414-481-8303 www.radyne.com
PRAXAIR DISTRIBUTION INC. 7000 High Grove Blvd Burr Ridge Illinois 60527-7596 800-772-9247 • 800-772-9985	1606	Q		RAM 3003 See Quality Vision International
PRECISION COATING COMPANY 51 Parmenter Rd Hudson Massachusetts 01749-3213 401-597-5000 www.ddlibiasio@precisioncoating.com	5638	QAD INC 100 Innovation Place Santa Barbara California 93108 630-719-4873 www.qad.com	1869	RAM PRECISION TOOL INC 1626 139 Gunnville Rd Lancaster New York 14086-9017 716-759-8722 • 716-759-8747 www.ramprecisiontool.com
PRECISION GRINDING INC 2101 Wenonah Oxmoor Rd Birmingham Alabama 35211-5941 88-934-7463 • 205-942-2073 www.precisiongrinding.com	5720	QUALITY PLUS INC 170 Grove St Chicopee Massachusetts 01020-1818 413-594-5529 • 413-594-5596 www.qpmetrology.com	3241	RAPID AIR 5523 See Stamptech Inc
PRECISION JIG FIXTURE & METROLOGY 301 Rockford Park Dr NE 915 Berry Shoals Rd., Duncan, SC 29334 Rockford Michigan 49341-7817 616-866-8296 • 616-866-0677 www.pjfinc.com	5831	QUALITY VISION INTERNATIONAL 850 Hudson Ave Rochester New York 14621-4839 585-544-0450 • 585-544-0450 www.qvii.com	3003	RAZOR TOOL 5518 6 Adele Rd Woburn Massachusetts 01801-1911 781-654-1582 www.razortools.com
PRECISION LASER TECHNOLOGY LLC 1001 Lexington Avenue Rochester New York 14606 585-458-6208 • 585-458-6209 www.precisionlasertech.com	3154	<i>Principals:</i> Certified Comparator Products (CCP) ITACA KOTEM Optical Gaging Products RAM ShapeGrabber 3D Scanners		REALTRAC ERP 5721 32971 Capitol St Livonia Michigan 48152 734-793-3816 • 734-261-0909 www.realtrac.com/
		QUANTUM MACHINERY GROUP 10270 Birtcher Dr Mira Loma California 91752-1827 909-476-8007 • 909-476-8023 www.quantummachinery.com	5671	RECARB LLC 5642 28 Wolcott St Readville Massachusetts 02136-2432 617-593-8242 • 617-364-1760 www.recarbllc.com
				REGAL DIAMOND PRODUCTS 5547 1405 E 286th St Wickliffe Ohio 44092-2506 440-944-7700 • 440-944-7722 www.regaldiamond.com

REGO-FIX TOOL CORP 7752 Moller Rd Indianapolis Indiana 46268 317-870-5959 • 317-870-5955 www.rego-fix.com	5320	RIZE INC See Cimquest Inc	5036	ROEMHELD 927 Horan Dr Fenton Missouri 63026-2401 636-386-8022 • 636-386-8034	5661
RENISHAW INC 1001 Wesemann Drive West Dundee Illinois 60118 847-286-9953 • 847-286-9974 www.renishaw.com	3151	RIZE INC See Access Manufacturing Systems	5452	ROHNER 2650 NE Andresen Rd Ste 102 Vancouver Washington 98661-7352 360-885-7641 • 360-896-5748 www.rohner-usa.com	2140
REVERE COPPER See Admiral Metals	5516	ROBBJACK 3300 Nicolaus Rd Lincoln California 95648-9574 916-645-6045 • 916-645-0146 www.robbjack.com	5441	ROLLED ALLOYS 125 W Sterns Rd Temperance Michigan 48182-9567 800-521-0332 • 734-847-6917 www.rolledalloys.com	5232
RICE MACHINERY INC 1104 Pontiac Ave Cranston Rhode Island 02920-7994 401-781-3010 • 401-781-5462 www.ricemachinery.com	1734	ROBORIS USA LLC PO Box 7114 Goodyear Arizona 85338-0636 www.roboris.com	5031	ROLLOMATIC INC 1295 Armour Blvd Mundelein Illinois 60047 847-281-8552 • 847-281-8558 www.rollomaticusa.com	1706
RIGAKU ANALYTICAL DEVICES 30 Upton Dr Ste 2 Wilmington Massachusetts 01887-1017 781-328-1024 • 281-364-3628 www.rigaku.com/KT100S	3319	ROBOTIQ See Axis New England	3328	ROSEDALE PRODUCTS INC 3730 W Liberty Rd Ann Arbor Michigan 48103-9014 734-665-8201 • 734-665-2214 www.rosedaleproducts.com	3028
RITTAL CORP 1 Rittal Place Urbana Ohio 43078-5003 800-477-4000 • 937-390-5599 www.rittal.us	5035	ROCK RIDGE ABRASIVES 10 Beaumont Rd Unit A Wallingford Connecticut 06492-2455 203-793-1666 • 203-793-1668 <i>Principals:</i> Hypertherm Stratus Technologies	5743		

Machining of perfect cutting edges, cylindrical margins and chip breakers in ultra hard materials such as PCD, CBN, CVD, MCD and natural diamond. Precise and reliable **LaserSmart 501**.

The smart choice.

eastec

MAY 14-16, 2019
WEST SPRINGFIELD, MA

Visit us in booth #1706

ROLLOMATIC
www.rollomaticusa.com solutions@rollomaticusa.com

<p>ROSS MACHINERY SALES INC 1620 212 N Plalins Industrial Rd Wallingford Connecticut 06492 203-269-2950 • 203-269-2962 www.rossmachinery.com</p> <p><i>Principals:</i> Amada Grinders Belmont Equipment and Technologies Breton Machine Tools Electronic Service Products Fives Giddings & Lewis GF Machining Solutions Mitsui Seiki USA Supertec Grinders Victor Lathes</p> <p>ROSS SOLAR GROUP 5641 38 Beaver Brook Rd Danbury Connecticut 06810-6201</p> <p>ROTAREX INC NA 5583 221 Westec Dr Mt Pleasant Pennsylvania 45666 724-309-1940 www.rotarexfiretec.com</p> <p>ROYAL PRODUCTS 5469 See Cutler Industrial Sales</p> <p>RUF BRIQUETTING SYSTEMS 5759 See Automation Engineering Co</p>	<p>RUF BRIQUETTING SYSTEMS 3023 771 Sugar Ln Elyria Ohio 44035-6313 440-779-2747 • 440-328-4626 www.ruf-briquetter.com</p> <p>RUSH MACHINERY 1129 4761 State Route 364 Rushville New York 14544-9721 585-554-3070 • 585-554-4077 www.rushmachinery.com</p> <hr/> <p style="text-align: center;">S</p> <hr/> <p>S&W MANUFACTURING 3338 See W T Hight CO</p> <p>SAACKE NORTH AMERICA LLC 1156 197-B Byers Creek Rd Mooresville North Carolina 28117-6989 704-663-1002 • 704-664-2002 www.saacke-usa.com</p> <p><i>Principals:</i> Advanced Superabrasives, Inc. Gebr. Saacke GmbH & Co. KG TTB Engineering SA</p> <p><i>Representatives:</i> Alternative Grinding Solutions, Inc. 248-705-6435 • Huntley Illinois Tornquist Machinery, Inc. 714-572-6830 • Brea California Hartech Group 303-883-9598 • Denver Colorado</p>	<p>SAMCHULLY WORKHOLDING 5469 See Cutler Industrial Sales</p> <p>SANDVIK COROMANT 1118 See Lindco Springfield Co</p> <p>SANKEN INDUSTRY CO. LTD. 5749 2-20-11 Higashi-Tateishi Katsushika-Ku Tokyo 124-0013 Japan 81-3665-76020 • 81-3369-69595 www.sanken-mo.co.jp/en</p> <p>SANYO DENKI 3145 See CPU Automation Inc</p> <p>SATURN INDUSTRIES INC 1237 PO Box 367 157 Union Turnpike Hudson New York 12534-0367 518-828-9956 • 518-828-9868 www.saturnedm.com</p> <p>SAUTER NORTH AMERICA INC 5423 44099 Plymouth Oaks Boulevard Suite 104 Plymouth Michigan 48170 734-207-0900 www.sauter-feinmechanik.com</p> <p>SAVAGE SAWS 2143 31 Commerce St East Haven Connecticut 06512-4113 203-468-4100 www.savagesaws.com</p>
---	--	--



KASTOmicut.
Semi-automatic miter cutting bandsaw.

The KASTOmicut allows you to perform sophisticated cuts in a powerful space saving package. Its innovative design incorporates a rotary table for mitering up to 60° (-45° / +60°) with a hydraulically supported and controlled saw feed.

See for yourself
www.kasto.com



See us at Booth #1661

T-Type blades and Hollow Ground blades:

- **M2** for general usage with excellent toughness
- **Cobalt** for highest heat resistance and higher RPM applications
- **T15PM** for difficult to machine materials with good heat resistance

Micro-grain Carbide Tipped Double End T-Type blades and Single End Hollow Ground blades.

Solid Carbide T-Type blades for longer wear, less galling, and better finish at high speeds.

All blades available tin coated.

SEE US AT EASTEC BOOTH # 5542
MAY 14-16, 2019, W. SPRINGFIELD MA

PREMIER TOOLING FOR THE MANUFACTURING INDUSTRY

109 Scott Road, Waterbury, CT 06705
PHONE (203) 753-2114 FAX (203) 756-5489
Call Today for Our Free Tooling Catalog
www.sommatool.com sales@sommatool.com

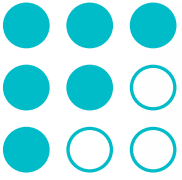

eastec®

Visit us at
Booth #1444



Introducing a NEW dimension to machining complex parts.

The SR-38B offers greater capacity and capability.

With 38mm capacity, B-axis versatility, and our efficient Star Motion Control System, the NEW 10-axis SR-38B Automatic Lathe raises the bar in productivity, accuracy and versatility.

- Designed for complex machining with rigid construction design to handle bar stock up to 1-1/2" (1.500) diameter.
- Fully independent 8-station back working with Y-axis for overlapping back work with a variety of tooling available.



- Two tool turning capability for heavy turning.
- Power-driven B-axis capable of working with main/sub-spindle.
- Large list of tooling is available for various machining operations.
- Suitable for long or short components, can be used with or without guide bushing.
- Capacity, versatility and precision in one package.

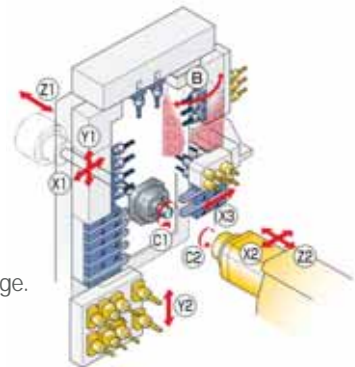

star®
Perfection in motion.

SCHLUMPF INC 39 Enterprise Dr # 1 Windham Maine 04062-5697 207-893-1903 • 207-893-1905 www.schlumpf-inc.com	3056	SCHUNK See Minuteman / Empire Automation Systems	3301	SCHUTTE CORP 4055 Morrill Rd Jackson Michigan 49201-7013 517-782-3600 • 517-782-3363 www.schutteusa.com	1056
SCHMALZ See Minuteman / Empire Automation Systems	3301	SCHUNK INC 211 Kitty Hawk Dr Morrisville North Carolina 27560 919-572-2705 www.schunk.com	5433	SCIAPS INC 5 Constitution Way Woburn Massachusetts 01801-1023 339-927-9455 • 339-600-3038 www.sciaps.com	3125



**HARSH
CONDITIONS
DESTROYING
YOUR CHUCKS?**

*Proffline® Sealed Chucks are designed
to take on the nastiest jobs.*

High pressure coolant, swarf, metal fines, and cast iron applications are the hazards of today's cutting environments. These conditions can contaminate or wash out other chucks causing machine downtime for maintenance and a loss of productivity.

Not with Proffline Sealed Chucks.

Available in various sizes ranging from 6" - 64", Proffline Sealed Products keep your machines up and running through the harshest conditions without daily maintenance. That means consistent grip force, high machine up time, and better productivity.

www.SMWautoblok.com // 847.215.0591

SCIENTIFIC CUTTING TOOLS INC 110 W Easy St Simi Valley California 93065-1689 805-584-9495 www.sct-usa.com	5224
SCYTEC CONSULTING INC. See Nexas America LLC	5527
SEEBURGER INC 1230 Peachtree St NE Ste 1020 Atlanta Georgia 30309-3551 678-638-4894 • 770-604-3885 www.seeburger.com	5844
SEIBU WIRE EDMS See Kgc International Corp	1662
SERVICE STEEL AEROSPACE CORP 827 Marshall Phelps Rd Windsor Connecticut 06095-2108 860-688-8393 • 860-683-2337 www.ssa-corp.com	5744
SEYI AMERICA See Stamptech Inc	5523
SHAPEGRABBER 3D SCANNERS See Quality Vision International	3003
SHELL LUBRICANTS See Dennison Lubricants	5662
SHEPHERD CASTER See W T Hight CO	3338
SHINING 3D See Cimquest Inc	5036
SHOPFLOORCONNECT 100 Discovery Way Unit 110 Acton Massachusetts 01720-4481 978-628-2700 • 978-263-2048 www.wintriss.com	5668
SHOPTECH 180 Glastonbury Blvd Ste 303 Glastonbury Connecticut 06033-4439 860-525-2143 • 860-633-0741 www.shoptech.com	5552
SIC MARKING USA INC 137 Delta Dr Pittsburgh Pennsylvania 15238 412-487-1165 • 412-487-1995 www.sic-marking.com	323
SIEMENS INDUSTRY INC 390 Kent Ave Elk Grove Vlg Illinois 60007-1902 847-640-1595 • 847-378-1918 www.usa.siemens.com/cnc	2012
SIEMENS PLM SOFTWARE See Swoosh Technologies	5338
SIMASV See J&S Machine Inc	5820

See us at Booth #2013

SIMTEK USA INC. 13 Fairfield Ave Little Falls New Jersey 07424-1264 862-757-8130 www.simtek.com	5636	SOLIDXPRTS INC 2650 Marie Curie Saint-Laurent Quebec H4S 2C3 Canada 514-343-9111 • 514-343-9196 www.solidxperts.com	5670	<i>Representatives:</i> Maine Oxy 800-377-9433 • Milford Massachusetts Haun Welding 800-439-4286 • Scranton Pennsylvania Arc3 Gases 804-644-4521 • Richmond Virginia
SIR MECCANICA SPA Viale Europa 37 Catanzaro Cz 88100 Italy 39-0961-769696 www.sirmeccanica.com	5445	SOMMA TOOL CO 109 Scott Rd Waterbury Connecticut 06705-3202 203-753-2114 • 203-756-5489 www.sommatool.com	5542	SUGINO CORP. 5759 See Automation Engineering Co
<i>Representatives:</i> AMS Automation Inc 713-460-8881 • Houston Texas DBH Distributors Inc 901-348-1155 • Memphis Tennessee		<i>Representatives:</i> Ray H. Morris Co. 800 243 0662 • New Britain Connecticut		SUHNER INDUSTRIAL PRODUCTS INC 5020 43 Anderson Rd PO Box 1234 Rome Georgia 30162-1234 706-235-8046 • 706-235-8045 www.suhner.com
SISMA USA INC 30 Chapin Rd Ste 1205 Pine Brook New Jersey 07058-9398 973-214-9970 • 212-202-5303 www.sisma.com	2104	SOUTHWICK & MEISTER INC 1455 N Colony Rd Meriden Connecticut 06450-1979 203-237-0000 • 203-634-4509	5387	SUMITOMO ELECTRIC CARBIDE INC 5236 1001 E Business Center Dr Mt Prospect Illinois 60056-6080 847-635-0044 • 847-635-7866 www.sumicarbide.com
SLM SOLUTIONS NA INC 48561 Alpha Dr Ste 300 Wixom Michigan 48393-3458 248-243-5400	5733	SPIDERCOOL 401 Governor's Highway South Windsor Connecticut 06074-2510 860-291-0670 • 860-291-0673 www.Spidercool.com	1241	SUMMIT 5662 See Dennison Lubricants
SME 1000 Town Center Ste 1910 Southfield Michigan 48375 313-425-3000 • 313-425-3400 www.sme.org	1164	SPRAGUE OPERATING RESOURCES LLC 185 International Drive Portsmouth New Hampshire 03801 855-466-2842 www.spragueenergy.com	3313	SUNNEN PRODUCTS CO 2111 7910 Manchester Rd Saint Louis Missouri 63143-2793 314-781-2100 • 314-781-2268 www.sunnen.com
<i>Principals:</i> SME Education Foundation SME Media Tooling U-SME		STAMPTECH INC 445 West Queen St. Southington Connecticut 06489-1171 860-628-9090 • 860-628-5454 www.stamptechinc.com	5523	SUPERTEC GRINDERS 1620 See Ross Machinery Sales Inc
SME EDUCATION FOUNDATION See SME	1164	<i>Principals:</i> Dorner Mfg Rapid Air Seyi America Unist		SUPRA ALLOYS A DIV OF TITAN METAL FABRICATORS INC 5643 352 Balboa Cir Camarillo California 93012-8644 805-388-2138 • 805-987-6492 www.supraalloys.com
SME MEDIA See SME	1164	STANDARD MODERN LATHES See Racer Machinery International Inc	1638	SURGICALLY CLEAN AIR 5735 6300 Viscount Rd Unit 1A Mississauga Ontario L4V 1H3 Canada 877-440-7770 • 905-671-3777 www.surgicallycleanair.com
SMITH & WESSON PRECISION COMPONENTS 2100 Roosevelt Ave Springfield Massachusetts 01104-1698 413-747-3482 • 413-747-3423 www.smith-wesson.com	5365	STAR CNC MACHINE TOOL CORP / EUROTECH ELITE 161 Sanrico Drive Manchester Connecticut 06042 860-783-5555 • 860-783-5552 www.netoolcorp.com	1444	SW NORTH AMERICA INC 1726 30160 Lyon Industrial Court New Hudson Michigan 48165 248-617-3800 www.sw-machines.de/us
SMW AUTOBLOK CORP 285 Egidi Dr Wheeling Illinois 60090-2653 847-215-0591 • 847-215-0594 www.smwautoblok.com	2013	STARRETT COMPANY 121 Crescent St Athol Massachusetts 01331-1915 978-248-3189 • 978-249-8495 www.starrett.com	5045, 3011	SWIVELLINK 3145 See CPU Automation Inc
<i>Representatives:</i> SMW Autoblok Corp. Mark Yeaton-Regional Sales Manager 351-322-3048 • Westford Massachusetts		STOR-LOC CORP 880 N Washington Ave Kankakee Illinois 60901-2004 800-786-7562 • 800-315-8769 www.storloc.com	5712	SWOOSH TECHNOLOGIES 5338 1422 Elbridge Payne Rd Ste 230 St. Louis Missouri 63017-8521 314-549-8110 www.swooshtech.com
SOFT ROBOTICS See Minuteman / Empire Automation Systems	3301	STRATUS TECHNOLOGIES See Rock Ridge Abrasives	5743	<i>Principals:</i> Siemens PLM Software
SOLAR ATMOSPHERES 1969 Clearview Rd Souderton Pennsylvania 18964-1021 215-721-1502 • 215-723-6460 www.solaratm.com	1251	STRONG HAND TOOLS 8750 Pioneer Blvd Santa Fe Springs California 90670-2006 800-989-5244 • 562-949-4875 www.stronghandtools.com	5627	SYIL AMERICA INC 1808 1887 N Bayshore Dr Coos Bay Oregon 97420-2565 541-404-7999 • 541-435-0061 www.us.syil.com
SOLIDWORKS CAM See Access Manufacturing Systems	5452			SYNTEC TECHNOLOGY INC 5130 766 Pinefalls Ave Walnut California 91789-3027 909-551-0187 www.syntecamerica.com

T

TAKACHIHO AMERICA INC. 1 Pierce Pl Ste 285W Itasca Illinois 60143-3175 630-917-9258 www.takachiho-america.com/	5741	TECNOMAGNETE INC 6655 Allar Dr Sterling Hts Michigan 48312-2603 586-276-6001 • 586-276-6003 www.tecnomagnetete.com	2145	THE CHARLES C LEWIS CO 209 Page Blvd PO Box 1810 Springfield Massachusetts 01104 413-733-2121 • 413-736-8030 www.charleslewis.com	5142
TAPESWITCH CORPORATION 100 Schmitt Blvd Farmingdale New York 11735-1424 631-630-0442 • 631-630-0454 www.tapeswitch.com	336	TE-CO 100 Quinter Farm Rd Union Ohio 45322 937-836-0961 • 937-832-1274 www.te-co.com	5463	THE CUSTOM GROUP CENTER FOR MANUFACTURING TECHNOLOGY 30 Nashua St Woburn Massachusetts 01801-4565 781-935-4940 • 781-935-3904 www.customtrainingcenter.com	5582
TAYLOR-WINFIELD TECHNOLOGIES INC 3200 Innovation Place Youngstown Ohio 44509 330-259-8500 • 330-259-8538 www.taylor-winfield.com	2107	TELEDYNE DALSA See CPU Automation Inc	3145	<i>Principals:</i> Center for Manufacturing Technology	
TCI PRECISION METALS 240 E Rosecrans Ave Gardena California 90248-1942 310-323-5613 • 310-323-1255 www.tciprecision.com	5030	TELESIS TECHNOLOGIES INC 28181 River Dr Circleville Ohio 43113-9726 614-440-8071 • 740-477-5001 www.telesis.com	2005	THE HOPE GROUP 70 Bearfoot Rd Northborough Massachusetts 01532-1550 508-393-7660 • 508-393-8203 www.thehopegroup.com	5858
TECHNIFOR See Minuteman / Empire Automation Systems	3301			<i>Principals:</i> IDEC Parker	
TECNICRAFTS See Platinum Tooling	5146			THE JOSEPH FREEDMAN CO INC 115 Stevens St Springfield Massachusetts 01104-3120 413-781-4444 www.jfirecycle.com	1772

RISING ABOVE the REST

Bright AM™ Supports and Enables an Industrial Additive Manufacturing Work Flow, Including:

- ▶ Enhanced management of non-conformance scrap parts
- ▶ Advanced dispositioning and control of 3D-printed parts
- ▶ Extensive serialization functions for multiple parts with different serial numbers printed on the same build plate
- ▶ Advanced build plate ID functions
- ▶ Flexibility to track the real-time splitting and combining of parts in the various operation steps within the Work Order to optimize the routing of work on the production floor
- ▶ Validation of dynamic part quantities moving on to the next step in processing
- ▶ AM companies also need to manage the raw material usage that goes into each part (i.e. some parts require virgin material; others can have 1x or 2x used material or combining 1x with virgin material to print the part, based on its ultimate application and commercial end-use).



Focused on AM Production

To meet the operational demands of this new “AM” revolution, **Bright AM™**, a Manufacturing Execution System (MES) and integrated Quality Management System (QMS), has been designed to be an excellent results-oriented “fit” in this work-space. **Bright AM™** has been proven to be the best choice for businesses as they strive for continuous improvement in each operational step within their predefined additive manufacturing processes.

info@bright-am.com • ron.beltz@bright-am.com or ron.beltz@go-bluestreak.com • 888.785.0509 X710

THE ROBERT E. MORRIS COMPANY 5464
 910 Day Hill Rd
 Windsor Connecticut 06095-5727
 860-687-3300 • 860-687-3301
 www.robertemorris.com

THERMO FISHER SCIENTIFIC 339
 2 Radcliff Road
 Tewksbury Massachusetts 01876
 978-670-7460 • 978-215-6121
 www.thermoscientific.com/nilton

THINBIT 5348
 PO Box 80430
 Fort Wayne Indiana 46818
 888-844-6248 • 888-844-6329
 www.thinbit.com

TIERTIME CORPORATION 5836
 1765 Landess Ave # 338
 Milpitas California 95035-7019
 888-288-6124
 www.tieritime.com

TOOL-FLO MANUFACTURING INC 5519
 14745 Kirby Dr
 Houston Texas 77047
 713-941-1080
 www.toolflo.com

TOOLING U-SME 1164
 See SME

TOSHIBA BORING MILLS 1662
 See Kgk International Corp

TOYODA AMERICAS CORPORATION 1034
 316 W University Dr
 Arlington Heights Illinois 60004-1812
 847-253-0340 • 847-253-0540
 www.toyoda.com

TRAK MACHINE TOOLS 1434
 2615 Homestead Place
 Rancho Dominguez California 90220
 310-608-4422 • 310-764-2668
 www.trakmachinetools.com

TRIAG 5843
 See Advanced Machine & Engineering

TRIBALVISION 327
 295 Devonshire St
 Boston Massachusetts 02110-1220
 266-208-6128
 www.tribalvision.com/

TRIMECH 5137
 4461 Cox Rd Ste 302
 Glen Allen Virginia 23060-3331
 888-874-6324 • 704-943-9886
 www.trimech.com

TRU TECH SYSTEMS INC 1830
 PO Box 46965
 Mount Clemens Michigan 48046-6965
 586-469-2700 • 586-469-1344
 www.truetechsystems.com

TRUMPF INC 2004
 3 Johnson Avenue
 Farmington Connecticut 06032-2851
 860-255-6000 • 860-255-6424
 www.us.trumpf.com

TTB ENGINEERING SA 1156
 See Saacke North America LLC

TURPIN SALES & MARKETING INC 5570
 330 Cold Spring Ave
 W Springfield Massachusetts 01089-3756
 413-733-6700 • 413-747-2600
 www.turpinsales.com

Principals:
 Arno
 ICC / Zurn Oil
 MA Ford
 Vargus USA

TW METALS 5674
 83 Gold St
 Agawam Massachusetts 01001-2976
 413-786-1531 • 413-789-2023
 www.twmetals.com

TWO TECHNOLOGIES INC 3326
 419 Sargon Way
 Horsham Pennsylvania 19044-1266
 215-441-5305 • 215-441-0423

WE ARE CHUCK JAWS! THE LARGEST VARIETY IN THE USA!

SOFT CHUCK JAWS
USST 1.5mm x 60° Serrations

- For Kitagawa, Strong, TMX, Samchully, MMK & other chucks
- The largest variety in the USA!
- Many more sizes/styles available
- Available in steel or aluminum
- Quantity Discounts
- MANY PRICES REDUCED!

Chuck Model	Chuck Size	Groove Width	Hole Space	Hgt Inch	STEEL Part #	SET Price
B206	6"	0.472	0.787	1.5"	KT-6150F	\$ 22.95
B208	8"	0.551	0.984	2"	KT-8200F	\$ 40.70
B210	10"	0.630	1.181	2"	KT-10200F	\$ 45.84
B12	12"	0.709	1.181	2"	KT-12200F	\$ 72.00
B212	12"	0.827	1.181	2"	KT-12208F	\$ 72.00

COLLET PADS & TOP JAWS
 Convert Your 3 Jaw Chuck Into A Precision Bar Machine!

SBM

"S" Style • Warner & Swasey • Emergency Pads
 Serrated, Squares & Hexes • Top Jaws • Made in the USA!

Warner & Swasey Collet Pads
 Prices Starting At: **\$53.74** Set
 Part # CP-1000/1000-Y

"S" Style Collet Pads
 Prices Starting At: **\$54.60** Set
 Part # CP-812/20000-Y

Collet Pad Top Jaws
 For KITAGAWA B-208 Chucks
 Prices Starting At: **\$452.00** Set
 Part # CP-J-1000003-Y

GRIP-RITE HARD JAWS
 For 1.5mm x 60° Serration Chucks

- Designed for first operation roughing, expect runout between 0.005-0.010
- Reversible- for OD & ID workholding
- Ground tips and improved runout
- 2 steps (1 step also available)
- XTRA BITE hard jaws also available

Chuck Model	Chuck Dia	Part Number	Price Per Set
B206, HS06	6"	KT-60HJ2-U	\$245.75
B208, HS08	8"	KT-80HJ2-U	\$294.53
B210, HS10	10"	KT-100HJ2-U	\$36.60
B-12	12"	KT-120HJ2-U	\$391.99
B-212, HS12	12"	KT-128HJ2-U	\$390.92

OEM STYLE
 In Stock & Ready to Ship!

MACHINABLE VISE JAWS
10 PACK Aluminum Vise Jaws For 6" Vises

- Fits 6" vises
- 6061 T6 aluminum
- Hole space: 3.875"
- Hole center height: 0.937"
- Screw size: 1/2"
- 10 pairs per pack
- Made in the USA!

FREE SHIPPING!

Length	Height	Width	Part Number	Reg. Price	PROMO!
6"	2"	3/4"	VJ-601-10	\$ 155.20	\$ 132.70
6"	2"	1"	VJ-602-10	\$ 172.30	\$ 147.32
6"	2"	1-1/4"	VJ-603-10	\$ 203.80	\$ 174.25

Balanced TOOLHOLDERS

KINGSTON
 BALANCED TOOLHOLDERS

- **BALANCED** to 15,000 RPM
- **Runout: 0.0002" TIR** or better
- Manufactured to ISO 9002 quality control standards
- Certification included
- SAE 8620 alloy steel
- AT3 Class Accuracy
- Balanced holders result in less vibration, chatter & extended tool life.

QUANTITY DISCOUNTS!
10% OFF 10 HOLDERS

ENDMILL HOLDERS
 Prices Starting At: **\$49.95** each
 Part # CA0-25M138-K

COLLET CHUCKS
 Prices Starting At: **\$79.95** each
 Part # CA0-10ER25-K

Accu-Collets ER COLLETS
PRICES REDUCED ON COLLETS & SETS!

PRECISION ER Collets:
 0.0005" TIR or better

ULTRA PRECISION ER Collets:
 0.0002" TIR or better

- TRUE INCH and metric sizes
- Crafted from high quality European alloy spring steel
- GUARANTEED accuracy!

	Precision	Ultra Precision
OLD PRICE:	\$16.50	\$26.00
Starting At:	\$8.75	\$21.00
	each	each

HUGE VARIETY
 In Stock & Ready To Ship!

U S Shop Tools
 Machine Shop Tools & Metalworking Supplies
CALIFORNIA • MICHIGAN

VISIT US AT EASTEC 2019
Booth #5609

Order TOLL FREE: (800) 243-7701
 Fax TOLL FREE: (800) 342-3311
 Email: sales@usshoptools.com
 www.usshoptools.com

<p>TYKMA ELECTROX 3035 370 Gateway Dr Chillicothe Ohio 45601-2772 740-779-9918 • 740-779-9910 www.permanentmarking.com</p>	<p>UNITED PERFORMANCE METALS 5728 3475 Symmes Rd Hamilton Ohio 45015-1363 513-860-6500 • 513-874-6857 www.upmet.com</p>	<p>US SHOP TOOLS 5609 1340 S Allec St Anaheim California 92805-6303 800-243-7701 • 800-342-3311 www.usshoptools.com</p>
U		
<p>ULTIMAKER 5732 150 Cambridgepark Dr Ste 101 Cambridge Massachusetts 02140-2305 617-714-4748</p>	<p>UNITRONICS 3145 See CPU Automation Inc</p>	<p>US TOOL GROUP INC 5626 2000 Progress Dr Farmington Missouri 63640-9158 800-222-1771 • 800-886-8668 www.ustg.net</p>
<p>ULTRAFLEX POWER TECHNOLOGIES CORP 1138 158 Remington Blvd Ste 2 Ronkonkoma New York 11779-6966 631-467-6814 • 631-980-4065 www.ultraflexpower.com</p>	<p>UNIVERSAL ROBOTS 3328 See Axis New England</p>	V
<p>UNISIG 1235 N58W14630 Shawn Cir Menomonee Fls Wisconsin 53051-5966 262-252-3802 • 262-252-4075 www.unisig.com</p>	<p>UNIVERSAL ROBOTS USA INC 1017 5430 Data Ct Ste 300 Ann Arbor Michigan 48108-8944 844-462-6268 www.universal-robots.com/</p>	<p>VALBRUNA 5516 See Admiral Metals</p>
<p>Representatives: The Robert E. Morris Company 860-687-3300 • Windsor Connecticut</p>	<p>UNTHA SHREDDING TECHNOLOGIES 5759 See Automation Engineering Co</p>	<p>VANCE METAL FABRICATORS INC 1824 251 Gambee Rd Geneva New York 14456-1025 315-789-5626 • 315-789-1848 www.vancemetal.com</p>
<p>UNIST 5523 See Stamptech Inc</p>	<p>UPC LLC 5849 170 Research Pkwy Meriden Connecticut 06450-7144 860-214-5745 www.upc2.com</p>	<p>VAPOR HONING TECHNOLOGIES 5509 See Blast & Wash Systems</p>
	<p>UPS 5833 1045 University Ave Norwood Massachusetts 02062-2643 800-PICK-UPS www.ups.com</p>	<p>VARGUS USA 5570 See Turpin Sales & Marketing Inc</p>
		<p>VEKTEK LLC 5026 3812 South Leonard Rd St Joseph Missouri 64503 913-365-1045 • 816-364-6613 www.vektek.com</p>

The latest technology in workholding

Sequence at the Device! *Imagine the possibilities*

- Control the timing of individual devices on your fixture.
- Can be added after the fixture is built to assure proper sequencing.
- Use with single or double acting clamps; in clamp port, unclamp port, or both.
- Internal reverse free flow check valve allows for faster return.

Available in
Inch, Metric and
Low Pressure

Learn more about Vektek's
SEQUENCE VALVE that fits
in to the PORT...

Call Today:

800-992-0236

sales@vektek.com • www.vektek.com

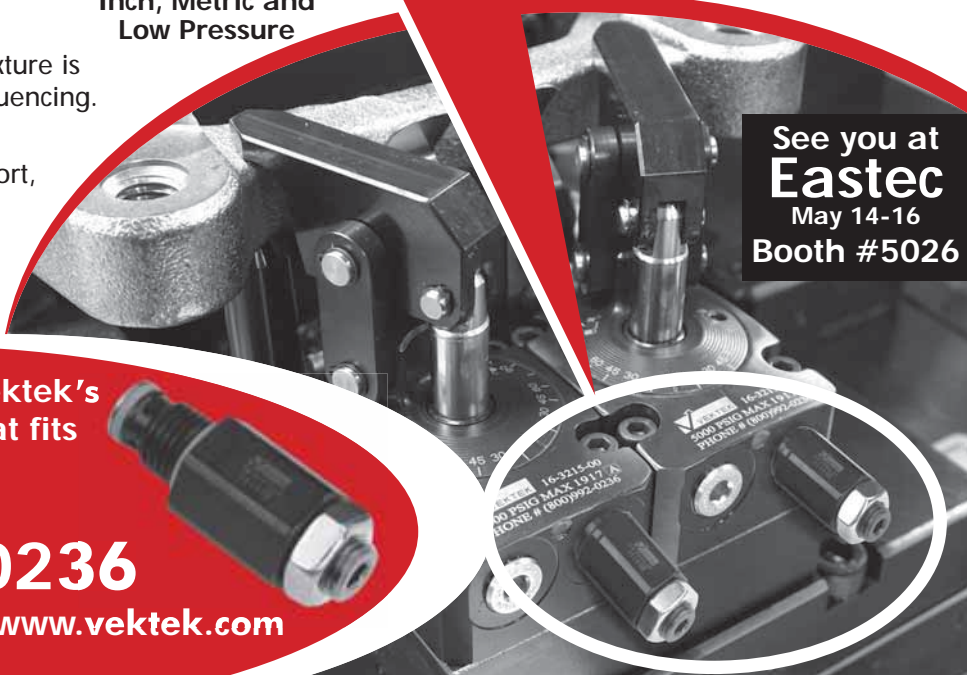

The Productivity Devices Company

See you at
Eastec
May 14-16
Booth #5026

- VELA INSTRUMENTS LLC** 5842
 5 Commonwealth Ave Unit 5
 Woburn Massachusetts 01801-1069
 617-276-5292
 www.velainstruments.com
- VENTILATION USA LLC** 3018
 6 Springdale Rd
 Manchester New Hampshire 03108
 603-622-1791 • 603-622-1792
 www.ventusa.com
- VENTION** 329
 4767 Rue Dagenais Unit 104
 Montreal Quebec H4C 1L8
 Canada
 514-242-6586
 www.vention.io
- VERISURF** 5036
 See Cimquest Inc
- VERISURF SOFTWARE INC**
5050
 4907 E Landon Drive
 Anaheim California 92807
 714-970-1683 • 714-701-0280
 www.verisurf.com
- VICTOR LATHES** 1620
 See Ross Machinery Sales Inc
- VISION ENGINEERING** 3254
 See L.F.O'leary Co.Inc/
 Glastonbury Southern Gage
- VISION ENGINEERING INC** 3322
 570 Danbury Road
 New Milford Connecticut 06776
 860-355-3776 • 860-355-0712
 www.visioneng.us
- VISIONGAUGE** 2034
 See Methods Machine Tools Inc
- VJ TECHNOLOGIES INC** 5835
 89 Carlough Rd
 Bohemia New York 11716-2903
 631-589-8800 • 631-589-8992
 www.vjt.com
- VKS - VISUAL KNOWLEDGE SHARE** 5370
 1241 Rue Des Cascades
 Chateauguay Quebec J6J 4Z2
 Canada
 855-201-4656 • 450-691-6467
 www.vksapp.com
- VLIER PRODUCTS** 5526
 82 South St
 Hopkinton Massachusetts 01748-2205
 800-821-1090 • 800-457-2020
 www.vlier.com
- VOLLMER OF AMERICA** 1158
 105 Broadway St
 Carnegie Pennsylvania 15106-2421
 412-278-0655 • 412-278-0520
 www.vollmer-group.com

VYTEK LASER SYSTEMS 2022
 195 Industrial Rd
 Fitchburg Massachusetts 01420-4654
 978-342-9800 • 978-342-0606
 www.vy-tek.com

W

W & H STAMPINGS & FINEBLANKING 5550
 45 Engineers Rd
 Hauppauge New York 11788-4019
 631-234-6161 • 631-582-1540
 www.whstamp.com

The Smart Line Is Here

Efficient tool data handling
 with connected hardware and software solutions

eastec®

Visit ZOLLER live!
 May 14 – 16, 2019, West Springfield, MA
 Booth #5436

www.zoller-usa.com

Easily create a smart factory by combining Smart Cabinets, presetting and measuring machines, and TMS Tool Management Solutions software with the z.One central tool database from ZOLLER. With ZOLLER, it's that easy to get started with Industry 4.0!

Experience networked production live
 – with the virtual reality app from ZOLLER.
 Download now!

ZOLLER®
 expect great measures

W T HIGHT CO 42 Winter St Ste 18 Pembroke Massachusetts 02359-4958 800-445-4082 • 781-682-7992 www.wthight.com	3338	WALKER MAGNETICS 600 Day Hill Road Windsor Connecticut 06095 508-853-3232 • 508-852-8649 www.walkermagnet.com	5543	WIELAND See CPU Automation Inc WINSLOW ENGINEERING INC N7677 N Peebles Ln Fond Du Lac Wisconsin 54937 920-921-6404 • 920-921-6409 www.winsloweng.com	3145 2109
<i>Principals:</i> Albion Casters Colson Caster Faultless Caster Footmaster Hudson Bearing Jarvis Caster Magliner Medcaster S&W Manufacturing Shepherd Caster		WALRUS AMERICA INC 20220 Hempstead Rd Ste 30 Houston Texas 77065-5665 281-955-8035 • 281-955-8037 www.walrusamerica.com	5748	WIREFREECNC See Macdac Engineering	5233
WALDMANN LIGHTING CO 9 Century Dr Wheeling Illinois 60090-6051 800-634-0007 • 847-520-1730 www.waldmannlighting.com	1614	WEIMA AMERICA INC 3678 Centre Cir Fort Mill South Carolina 29715-9733 803-802-7170 • 803-802-7098 www.weimaamerica.com	335	WORKPLACE MODULAR SYSTEMS LLC 562 Mammoth Rd Londonderry New Hampshire 03053-2101 603-622-3727 • 603-622-0174 www.workplacenh.com	5658
<i>Representatives:</i> Kenneth Crosby Company, Inc. 508-497-0048 • Hopkinton Massachusetts BlackHawk Industrial 413-382-7233 • Agawam Massachusetts Tiger Tool Supply 888-551-4490 • Glendale Heights Illinois		WENZEL AMERICA LTD 28700 Beck Rd Wixom Michigan 48393-3604 248-295-4300 • 248-319-1271 www.wenzelamerica.com	3223	WTO USA 13900 S Lakes Dr Ste F Charlotte North Carolina 28273-7119 704-714-7765 • 704-714-7767 www.wto-usa.com	5223
		WERTH INC 8 Custom Dr Old Saybrook Connecticut 06475-4008 860-399-2445 • 860-399-6784 www.werthinc.com	3213	WTU SYSTEMS LLC 582 Tam O Shanter Las Vegas Nevada 89109-1495 424-386-9455 www.hidow.com	5846
		WICKMAN MACHINE TOOL INC 1521 Unit F Imhoff Dr Lake In the Hills Illinois 60156 847-458-6400 • 847-458-6401 www.wickman-usa.com	1822		

EASTEC // WEST SPRINGFIELD, MA // BOOTH #1158
WESTEC // LONG BEACH, CA // BOOTH #1831

COMPLEX FORMS NEED STRAIGHTFORWARD SOLUTIONS: VOLLMER

//// ////

To shape the future you will need forward-looking PCD tools – and intelligent solutions for their production, processing and maintenance. VOLLMER supports you: with innovative PCD sharpening and eroding machines, economical automation options and strong services. For the highest flexibility, efficiency and quality. The future takes shape: with VOLLMER.

VGrind 360
Tool & Cutter Grinder

VPulse 500
Wire Erosion Machine

www.vollmer-group.com

VOLLMER OF AMERICA CORP. // Carnegie, PA 15106 // +1412 278 0655

Y

YAMAZEN INC 35 Holland Dr Newington Connecticut 06111 847-882-8800 • 847-882-4296 www.yamazen.com	1005
YARDE METALS INC 45 Newell St Southington Connecticut 06489-1424 860-406-6061 • 860-406-6040 www.yarde.com	2039
YASDA See Methods Machine Tools Inc	2034
YASKAWA AMERICA, INC. See Axis New England	3328
YG-1 See Lindco Springfield Co	1118
YG-1 TOOL CO 730 Corporate Woods Pkwy Vernon Hills Illinois 60061-3153 847-634-3700 • 847-634-3755 www.yg1usa.com	5474
YLM See J&S Machine Inc	5820

YMW TAPS USA 1507 E McFadden Ave Santa Ana California 92705-4307 714-782-0960 • 714-380-6324 www.ymw taps.com	5522
YUASA INTERNATIONAL 1320 Landmeier Rd Elk Grove Village Illinois 60007-2412 847-243-3380 • 847-981-0757 www.yuasa-intl.com	1748

Z

ZEISS INDUSTRIAL METROLOGY 6250 Sycamore Ln N Maple Grove Minnesota 55369 763-744-2473 • 763-533-0219 www.zeiss.com/metrology	3159
ZIMMERMANN INC 30587 Century Dr Wixom Michigan 48393-2062 248-305-9707 • 248-305-9751	2137
ZIRCAR REFRACTORY COMPOSITES PO Box 489 Florida New York 10921-1109 845-651-2200 • 845-651-1515 www.zrci.com	5822

ZOLLER INC 3900 Research Park Drive Ann Arbor Michigan 48108 734-332-4851 • 734-332-4852 www.zoller-usa.com	5436
--	-------------

Reliability is everything.

Without it, how can there be trust? Proven reliability is the reason that national defense, medical, aerospace and most any industry that helps make the world work have chosen Vlier—with confidence.

Visit us in Booth 5526 to learn more about our knurled press fit plungers!

Insist on Vlier. Vast Product Selection. Versatile Applications. Superior Value and Performance.

Simple Installation.
Reliable Performance.



Vlier Products,
a unit of Hutchinson Defense & Mobility Systems
1.800.821.1090 | vlier@vlier.com | vlier.com

ISO:9001 Certified
AS9100 Certified
Cage Code: 01226



DIRECTLY **ENHANCING** THE MANUFACTURING
AND ENGINEERING **TALENT** PIPELINE

INSPIRE – **SUMMITS**

Hands-on manufacturing
challenges and competitions

PREPARE - sme | **prime**

Industry-informed curriculum,
equipment and training

SUPPORT – **SCHOLARSHIPS**

\$2 million in manufacturing
scholarships awarded annually

Head to the SME Zone to speak with a Foundation representative

smeef.org

3D Printing/Additive Manufacturing

3D Systems	5241
ABTech Inc	3012
Access Manufacturing Systems	5452
Aimtek Inc	2108
Alpha Additive Manufacturing Technologies	5615
Alpha Laser - US	2105
Autodesk Inc	5326
Blue Photon Technology	
& Workholding Systems LLC	5734
Brooks Assoc Inc	1206
CAD BLU Inc	5840
Cimquest Inc	5036
Cincinnati Inc	1844
FARO Technologies Inc	3135
GF Machining Solutions	1420
Hawkeye Innovation LLC	5838
Matterhackers	5848
Methods Machine Tools Inc	2034
Mitsui Seiki USA	1620
Proto Labs Inc	5752
Purex Inc	2102
Renishaw Inc	3151
Rize - Full-Color Industrial	
3D Printing	5036, 5452
Siemens Industry Inc	2012
SISMA USA Inc	2104
SLM Solutions NA Inc	5733
The Robert E. Morris Company	5464
Tiertime Corporation	5836
Ultimaker	5732

3D Scanning/Imaging

Capture 3D Inc	3044
Cimquest Inc	5036
ECM Global Measurement Solutions	3008
FARO Technologies Inc	3135
Geomagic	5036
Helmel Engineering Products Inc	3207
Hexagon Manufacturing Intelligence	3103
Matterhackers	5848
Metronor Inc	3127
Nikon Metrology Inc	3203
North Coast Technical	1865
Quality Vision International	3003
ShapeGrabber 3D Scanners	3003
VJ Technologies Inc	5835
Wenzel America Ltd	3223

Abrasive Machines

Aerospace Alloys Inc	5729
Aquajet Cutting Technology	1654
Blast & Wash Systems	5509
Blast it All	5509
Burr King Manufacturing Co	1713
Engis Corp	5028
KMT Waterjet Systems Inc	1344
Nagel Precision Inc	5850
New England Metal Finishing	
& Precision Finishing Services	5136
New England Sales Inc	2026
Okamoto Corp	1044
OMAX Corp	1106
Rush Machinery	1129
Savage Saws	2143
Tru Tech Systems Inc	1830

Abrasives

Airgas	1656
Blast & Wash Systems	5509
Brush Research Manufacturing Co	5608
Burr King Manufacturing Co	1713
Butler Bros	5637
Cool Grind Technologies	1745
Diacut Inc	3226
Engis Corp	5028
Fastenal Company	5575
Mirka / Cafro	1711
New England Metal Finishing	
& Precision Finishing Services	5136
New England Sales Inc	2026
Praxair Distribution Inc.	1606
Regal Diamond Products	5547
Rock Ridge Abrasives	5743
Savage Saws	2143
Sunnen Products Co	2111
Turpin Sales & Marketing Inc	5570
US Shop Tools	5609
Vapor Honing Technologies	5509

Actuators

Air Inc	3039
Airline Hydraulics Corp	1820
Axis New England	3328
Faxon Engineering	1768
Heidenhain Corp	1634
Hiwin Corporation	3034
IAI	3301
Minuteman / Empire Automation Systems	3301
Paletti USA	3239
Parker Hannifin	3328
Pearse-Bertram LLC	3245
Schunk Inc	5433
The Hope Group	5858
Vention	329

Adhesives

Action Bearing Co	5514
Branson Ultrasonics Corp	3235
Bristol Tape Corporation	5851
Curbell Plastics Inc	5771
Mitee-Bite Products LLC	5459

AGVs (Automated Guided Vehicles)

Axis New England	3328
Ecoclean Inc	3019
Omron	3328
Tapeswitch Corporation	336

Air Filtration

AER Control Systems LLC	5762
Aimtek Inc	2108
Air Cleaning Specialist	5509
Air Filtration Systems	3059
Airflow Systems Inc	3309
Aquest Corp	3347
Blast & Wash Systems	5509
Custom Service Solutions Inc	3218
Diversitech Air Filtration	5509
Electrodes Inc	1128
EM Benson Co	5141

Harvey Industries International Inc	3343
Ketcham & Co Inc	3306
Modern Tools Inc	1127
Nordfab Ducting	3025
Purex Inc	2102
Rittal Corp	5035
Rock Ridge Abrasives	5743
The Hope Group	5858
Ventilation USA LLC	3018

Air Systems

Airflow Systems Inc	3309
Aquest Corp	3347
Custom Service Solutions Inc	3218
Harvey Industries International Inc	3343
Ketcham & Co Inc	3306
Rittal Corp	5035
The Hope Group	5858
Ventilation USA LLC	3018

Assembly Equipment & Systems

Air Inc	3039
Atlas Copco Tools/Palmac	1134
Branson Ultrasonics Corp	3235
Carr Lane Manufacturing/ Carr Lane Roemheld	5659
Faxon Engineering	1768
FlexArm Inc	5541
GKS Lifting and Moving Solutions LLC	3325
Hiwin Corporation	3034
item Northeast	1861
Kolver	5619
Purex Inc	2102
Roemheld	5661
Taylor-Winfield Technologies Inc	2107
Ultraflex Power Technologies Corp	1138
Vention	329
Workplace Modular Systems LLC	5658

Associations

Alliance For American Manufacturing	3229
American Society of Mechanical Engineers	5751
Boston Tooling and Machining Association	
sponsored by CompuMachine	5245
NTMA	1862
Siemens Industry Inc	2012
SME	1164
SME Education Foundation	1164
SME Media	1164
The Custom Group Center	
For Manufacturing Technology	5582
Tooling U-SME	1164

Automated Storage & Retrieval Systems

Dorner Mfg	5523
Elm Electrical	1852
Kasto Inc	1661
Modula Inc	1254
Tapeswitch Corporation	336

Automation Equipment

Air Inc	3039
Airline Hydraulics Corp	1820
Ajax Tocco Magnethermic Corp	1026
Alpha Additive Manufacturing Technologies	5615
ATAGO USA Inc	5745
Axis New England	3328
Blast & Wash Systems	5509
Branson Ultrasonics Corp	3235
Capture 3D Inc	3044
Carlson Fabrication Solutions	2128
Copley Controls	3328
CPU Automation Inc	3145
Crest Ultrasonics Corp	3058
Cubic Machinery Inc	1021
Dorner Mfg	5523
ECM Global Measurement Solutions	3008
Elm Electrical	1852
Engis Corp	5028
Erowa Technology Inc	1628
Fagor Automation Corp	2123
Force Automation	5509
GF Machining Solutions	1420
Gibson Engineering Co Inc	3045
GKS Lifting and Moving Solutions LLC	3325
Hiwin Corporation	3034
Infranor	3145
INIRAM Precision Machine Tool Inc	1468
item Northeast	1861
JH Robotics Inc	1462
Kasto Inc	1661
Kolver	5619
L.F.OiLEARY CO.INC/ GLASTONBURY SOUTHERN GAGE	3254
Lang Technovation Co	5483
Laser Measuring Technologies LLC	3122
Lubrication Technologies Inc	5737
Metrologic Group Services	3228
MIDACO Corp	1858
Mitsubishi EDM / MC Machinery Systems Inc	1426
Modula Inc	1254
MULTICAM EAST	1035
North Coast Technical	1865
Nysus Solutions LLC	3259
Omron	3328
Origin Technologies Corp	1854
Paletti USA	3239
Parker Hannifin	3328
Pearse-Bertram LLC	3245
Preco Inc	5237
Pro Ultrasonics	3055
Purex Inc	2102
Renishaw Inc	3151
Sanyo Denki	3145
Suhner Industrial Products Inc	5020
SW North America Inc	1726
Taylor-Winfield Technologies Inc	2107
Teledyne Dalsa	3145
Telesis Technologies Inc	2005
The Hope Group	5858
TRUMPF Inc	2004
TYKMA Electro	3035
Unitronics	3145
Universal Robots	3328
Universal Robots USA Inc	1017
Vention	329
VJ Technologies Inc	5835
Winslow Engineering Inc	2109
Yamazaki Inc	1005
Yuasa International	1748
Zimmermann Inc	2137
Zoller Inc	5436

Balancing Equipment

BlackHawk / Kennametal	5563
Control Gaging Inc	3224
G II Solutions Inc	1253
GTI Spindle Technology Inc	5562
Haimer	1118
Haimer USA	5458
Kolver	5619
REGO-FIX Tool Corp	5320
Rollomatic Inc	1706
Rush Machinery	1129

Ball/Lead Screws & Repair Service

Action Bearing Co	5514
Alpine Bearing Co	5669
GTI Spindle Technology Inc	5562
Hiwin Corporation	3034
New England Miniature Ball	5364
Paletti USA	3239

Bar Feeders

Ajax Tocco Magnethermic Corp	1026
Edge Technologies	1348
HEM Inc	2038
Marubeni Citizen Cincom	1406
Star CNC Machine Tool Corp /	
Eurotech Elite	1444
Yuasa International	1748

Bearings

ABTech Inc	3012
Action Bearing Co	5514
Advanced Machine & Engineering	5843
Alpine Bearing Co	5669
Chambrelan SAS	2130
Fixtureworks	5766
GTI Spindle Technology Inc	5562
HASCO America Inc.	5010
Hirschmann Engineering USA Inc	1231
Hiwin Corporation	3034
Laroche Foundry Ltd	5362
New England Miniature Ball	5364
Northland Tool & Electronics	5828
W T Hight CO	3338
Wickman Machine Tool Inc	1822

Bending

Advance Welding	5870
Cincinnati Inc	1844
CLOMEA / 3C	5820
Ercolina - CML USA Inc	1753
J&S Machine Inc	5820
KAASST Machine Tools Inc	2134
Millinocket Fabrication & Machine LLC	2126
Mitsubishi EDM / MC Machinery Systems Inc	1426
Northeast Machinery Sales/FlexCNC	1228
Omni Services	5612
Proto Labs Inc	5752
Rapid Air	5523
Sanken Industry Co. Ltd.	5749
SIMASV	5820
Tapeswitch Corporation	336
TRUMPF Inc	2004

Vance Metal Fabricators Inc	1824
YLM	5820

Boring Machines

American Systems & Equipment Corp	1022
Brooks Assoc Inc	1206
Dynamic International	1454
Edac Technologies	5553
Hannsa Precision	1027
KAASST Machine Tools Inc	2134
Kays Engineering/DeHoff/Eldorado	1612
Kgk International Corp	1662
Methods Machine Tools Inc	2034
Millinocket Fabrication & Machine LLC	2126
Racer Machinery International Inc	1638
Ross Machinery Sales Inc	1620
Sir Meccanica SpA	5445
Standard Modern Lathes	1638
Toshiba Boring Mills	1662
Toyoda Americas Corporation	1034
Yamazaki Inc	1005

Boring Tools Bars Heads

Allied Machine & Engineering	5453
ARCH Cutting Tools & Beamer Laser Marking Systems	5666
Big Kaiser Precision Tooling Inc	5248
BlackHawk / Kennametal	5563
Carmex Precision Tools LLC	5016
Ceratizit	1118
Cutler Industrial Sales	5469
EM Benson Co	5141
Fullerton Tool Co	5736
Genevieve Swiss Industries Inc	5133
Greenleaf Corp	5317
Guhring Inc	5333
heimatec GmbH	5146
HORN USA Inc	5353
Internal Tool	5853
iSwiss Corporation	5616
Kycocera Precision Tools Inc	5573
Lindco Springfield Co	1118
Lovejoy Tool Co	5242
MAPAL Inc	5327
Mitsubishi Materials USA	5468
NTK Cutting Tools	5564
OSG USA INC	5652
Platinum Tooling	5146
REGO-FIX Tool Corp	5320
Sandvik Coromant	1118
Scientific Cutting Tools Inc	5224
THINBIT	5348
Tool-Flo Manufacturing Inc	5519
Vollmer Of America	1158

Brazing & Soldering Equipment

Aimtek Inc	2108
Ajax Tocco Magnethermic Corp	1026
Ambrell Induction Heating Solutions	2008
CEIA USA Induction Heating Systems	1243
Faxon Engineering	1768
GH Induction Atmospheres LLC	2033
Hardline Heat Treating Inc	2011
LaserStar Technologies Corp	2100
Lynn Welding	2027
Purex Inc	2102
Radyne Corp	1102

Taylor-Winfield Technologies Inc	2107
Ultraflex Power Technologies Corp	1138

Broaching Equipment

Perry Technology Corp	5623
Somma Tool Co	5542
Takachiho America Inc.	5741

Brushes

BlackHawk / Kennametal	5563
Brush Research Manufacturing Co	5608
stratus technologies	5743

Buffing Compounds

BlackHawk / Kennametal	5563
Burr King Manufacturing Co	1713
Gesswein Co	5653
Mikro Industrial Finishing Co	5440

Burnishing Honing Lapping Tools

BlackHawk / Kennametal	5563
Engis Corp	5028
Gesswein Co	5653
Lindco Springfield Co	1118
Sunnen Products Co	2111

Calibration Equipment & Services

ABTech Inc	3012
ATAGO USA Inc	5745
Blum-Novotest, Inc.	5432
Dorsey Metrology International Inc	3119
ECM Global Measurement Solutions	3008
Electronic Service Products	1620
Fastenal Company	5575
Fischer Technology Inc	5738
Flexbar Machine Corp	3157
Fowler High Precision Inc	3251
Glastonbury Southern Gage Thread & Cylindrical Gages And Masters	3254
GTI Spindle Technology Inc	5562
Holts Precision Inc	3156, 5419
J & L Metrology Inc	3255
Johnson Gage Co	3042
Kolver	5619
L.F.O'leary Co.Inc/ Glastonbury Southern Gage	3254
Laser Measuring Technologies LLC	3122
Metrologic Group Services	3228
Mitutoyo America Corp	3111
Nikon Metrology Inc	3203
Pinpoint Laser Systems	3054
Pratt & Whitney Measurement Systems Inc	3006
Quality Plus Inc	3241
Renishaw Inc	3151
Rollomatic Inc	1706
Starrett Company	3011, 5045
Thermo Fisher Scientific	339
Verisurf Software Inc	5050
Wenzel America Ltd	3223

Castings

Conley Casting Supply Corp	5739
Laroche Foundry Ltd	5362
Millinocket Fabrication & Machine LLC	2126
Okamoto Corp	1044
VJ Technologies Inc	5835

Ceramic Components & Materials

Aimtek Inc	2108
Poco Graphite	1227

Chamfering Tools

Allied Machine & Engineering	5453
ANCA Inc	1244
ARCH Cutting Tools & Beamer Laser Marking Systems	5666
Big Kaiser Precision Tooling Inc	5248
BlackHawk / Kennametal	5563
Carbide Related Technologies, Inc.	5765
Carmex Precision Tools LLC	5016
Contour360	5559
Datron Dynamics Inc	5240
Fitz-Rite Products Inc	5645
Flexbar Machine Corp	3157
Fullerton Tool Co	5736
Genevieve Swiss Industries Inc	5133
Guhring Inc	5333
GWS Tool Group	5621
Hassay Savage Co	5774
HEULE Precision Tools	5385
HORN USA Inc	5353
Internal Tool	5853
Kyocera Precision Tools Inc	5573
Lexington Cutter	5469
Lindco Springfield Co	1118
Link Industries	5826
Lovejoy Tool Co	5242
Maxtool Corp.	5002
Mikron Corp Monroe	5426
Mitsubishi Materials USA	5468
Nexgen Tooling	5747
OG Bell Co	5767
OSG USA INC	5652
Scientific Cutting Tools Inc	5224
SIMTEK USA Inc.	5636
Thinbit	5348
Vollmer Of America	1158

Chuck Jaws & Collets

Belmont Equipment & Technologies	1248
Centaur Precision Tools Inc	5512
Edge Technologies	1348
EM Benson Co	5141
H & R	5469
Hardinge Inc	5444
Huron Machine Products	5000
iSwiss Corporation	5616
Jergens Inc	5644
Kitagawa-NorthTech Inc.	1152
Koma Precision Inc	5359
Northfield Precision Instrument Corp	5508
Platinum Tooling	5146
Rollomatic Inc	1706
Royal Products	5469
Samchully Workholding	5469
Schunk Inc	5433

SMW Autoblok Corp	2013
Somma Tool Co	5542
Southwick & Meister Inc	5387
Tecnicrafts	5146
US Shop Tools	5609
Wickman Machine Tool Inc	1822
Yuasa International	1748

Chucks

ABTech Inc	3012
Babin Machine Tool	1743
Belmont Equipment & Technologies	1248
Big Kaiser Precision Tooling Inc	5248
Chumpower Machinery Corp	5770
Emuge Corp	5369
Erowa Technology Inc	1628
FlexCNC	1228
H & R	5469
Hardinge Inc	5444
Hermann Schmidt Co	1723
Huron Machine Products	5000
Jergens Inc	5644
Kitagawa-NorthTech Inc.	1152
Koma Precision Inc	5359
Lang Technovation Co	5483
Lyndex-Nikken Inc	5533
Mapal Inc	5327
Mitee-Bite Products LLC	5459
Northfield Precision Instrument Corp	5508
R&R Fixtures LLC	3318
Rollomatic Inc	1706
Royal Products	5469
Samchully Workholding	5469
Schunk Inc	5433
SMW Autoblok Corp	2013
Triag	5843
US Shop Tools	5609
Walker Magnetics	5543
Yuasa International	1748

Clamps Hydraulic

Action Bearing Co	5514
Advanced Machine & Engineering	5843
Carr Lane Manufacturing/ Carr Lane Roemheld	5659
Clamptek USA Inc	5684
Emuge Corp	5369
Faxon Engineering	1768
Jergens Inc	5644
Koma Precision Inc	5359
Mitee-Bite Products LLC	5459
Northfield Precision Instrument Corp	5508
PAWS Workholding	5866
Roemheld	5661
Schunk Inc	5433
Strong Hand Tools	5627
Triag	5843
Vekttek LLC	5026

Clamps Pneumatic

Air Inc	3039
Belmont Equipment & Technologies	1248
Carr Lane Manufacturing/ Carr Lane Roemheld	5659
Clamptek USA Inc	5684
Emuge Corp	5369
Faxon Engineering	1768
Fixtureworks	5766
Hirschmann Engineering USA Inc	1231

Jergens Inc	5644
Koma Precision Inc	5359
Northfield Precision Instrument Corp	5508
Phillips Precision Inc	3342
Rollomatic Inc	1706
Schunk Inc	5433
Strong Hand Tools	5627
Triag	5843
Vekttek LLC	5026

Clamps Spring

Carr Lane Manufacturing/ Carr Lane Roemheld	5659
Fixtureworks	5766
H & R	5469
Hirschmann Engineering USA Inc	1231
Jergens Inc	5644
Phillips Precision Inc	3342
R&R Fixtures LLC	3318
Roemheld	5661
Schunk Inc	5433
SMW Autoblok Corp	2013
Strong Hand Tools	5627
Triag	5843

Cleaning & Pretreatment Equipment

Blast & Wash Systems	5509
Blast it All	5509
Branson Ultrasonics Corp	3235
Brush Research Manufacturing Co	5608
Chemetall US Inc	3234
Cleaning Technologies Group	3219
Comco Inc	5545
Crest Ultrasonics Corp	3058
Cutler Industrial Sales	5469
DuBois Chemicals Inc	5449
Ecoclean Inc	3019
Ensitech Inc	5758
Factory Cat	3339
Garboli	5820
Gibson Abrasive Equipment	5509
J&S Machine Inc	5820
JRI/JenFab Wash Systems	5509
Ketcham & Co Inc	3306
Kyzen Corporation	3027
LS Industries Inc	3043
Lucifer Furnaces Inc	2003
Magido USA	1118, 1838
Mikro Industrial Finishing Co	5440
New England Metal Finishing & Precision Finishing Services	5136
New England Sales Inc	2026
NITCO Industrial Cleaning Equipment & Commercial Products	3002
Pauway Corp	5549
Pro Ultrasonics	3055
stratus technologies	5743
Unist	5523
Vapor Honing Technologies	5509

CNC Controls & Accessories

Axis New England	3328
Babin Machine Tool	1743
Carlson Fabrication Solutions	2128
Datron Dynamics Inc	5240
Digipas Technologies Inc	5340
Electronic Service Products	1620

Fagor Automation Corp	2123
FANUC America Corp	1018
G II Solutions Inc	1253
Heidenhain Corp	1634
Kitagawa-NorthTech Inc.	1152
Matterhackers	5848
Mitsubishi Electric Automation Inc	1140
Nexas America LLC	5527
Quality Vision International	3003
Rice Machinery Inc	1734
Rollomatic Inc	1706
Siemens Industry Inc	2012
SpiderCool	1241
Syil America Inc	1808
Syntec Technology	5130
Trak Machine Tools	1434
Two Technologies Inc	3326
Zoller Inc	5436

Coating Equipment

Advanced Coating Service	5624
Aimtek Inc	2108
Cambridge Vacuum Engineering	5857
Noble Industrial Furnace	3354
Oerlikon Balzers Coating USA Inc	5567
Pauway Corp	5549
Purex Inc	2102
Unist	5523

Coatings

Advanced Coating Service	5624
Aimtek Inc	2108
Ajax Tocco Magnethermic Corp	1026
Alexandria Metal Finishers	5742
Anoplate Corp	5726
Armoly of Connecticut Inc	5246
Eureka Chemical Co	3243
Northeast Coating Technologies	5540
Pauway Corp	5549
Poco Graphite	1227
Precision Laser Technology LLC	3154
Tool-Flo Manufacturing Inc	5519

Composites

CGTech	5350
Curbell Plastics Inc	5771
NCSIMUL Hexagon Manufacturing Intelligence	5358
Plastics International	5366
Ultimaker	5732

Computer Services

Ecoclean Inc	3019
Nexas America LLC	5527

Computer-Aided Design (CAD)

Access Manufacturing Systems	5452
Air Inc	3039
Autodesk Inc	5326
Capture 3D Inc	3044
CGTech	5350
Cimquest Inc	5036
Dorsey Metrology International Inc	3119
ECM Global Measurement Solutions	3008

JH Robotics Inc	1462
Kalov Technologies	5821
Macdac Engineering	5233
Mastercam/CNC Software Inc	5249
Mastercam®	5233
NCSIMUL Hexagon Manufacturing Intelligence	5358
Precision Jig Fixture & Metrology	5831
Quality Vision International	3003
Siemens PLM Software	5338
Swoosh Technologies	5338
Verisurf Software Inc	5050

Computer-Aided Engineering Equipment

Capture 3D Inc	3044
CIMCO Americas LLC	5716
Geomagic	5036
InnovMetric Software Inc	3244
Vention	329

Computer-Aided Manufacturing (CAM)

3D Systems	5241
Access Manufacturing Systems	5452
Autodesk Inc	5326
Blum-Novotest, Inc.	5432
CAMWorks - World's most advanced CAM Software	5452
Capture 3D Inc	3044
CGTech	5350
Cimquest Inc	5036
ESPRIT/DP Technology Corp	5259
Griffo Brothers Inc	5034
InnovMetric Software Inc	3244
Macdac Engineering	5233
Mastercam	5036
Mastercam/CNC Software Inc	5249
Mastercam®	5233
NCSIMUL Hexagon Manufacturing Intelligence	5358
Open Mind Technologies USA Inc.	5228
Siemens Industry Inc	2012
Siemens PLM Software	5338
SolidWorks CAM - Powered by CAMWorks	5452
Swoosh Technologies	5338
Verisurf Software Inc	5050
Zoller Inc	5436

Computer-Integrated Manufacturing (CIM)

Access Manufacturing Systems	5452
Autodesk Inc	5326
AutoForm Engineering USA Inc	5467
Capture 3D Inc	3044
CIMCO Americas LLC	5716
Dassault Systemes	5233
Macdac Engineering	5233
NCSIMUL Hexagon Manufacturing Intelligence	5358
Verisurf	5036
VJ Technologies Inc	5835
WireFreeCNC	5233

**Consulting & Training
Statistical Analysis**

Cool Grind Technologies	1745
ECM Global Measurement Solutions	3008
Hexagon Manufacturing Intelligence	3103
High QA, Inc	341
Holts Precision Inc	3156, 5419
Metrologic Group Services	3228
The Custom Group Center For Manufacturing Technology	5582
Verisurf Software Inc	5050

Consulting Services

Acorn Industrial Products Co	5415
Ecoclean Inc	3019
Faxon Engineering	1768
JH Robotics Inc	1462
Lubrication Technologies Inc	5737
MCRL Inc / Fluid Chillers	1001
Nexas America LLC	5527
R & D Technologies	5776
Scytec Consulting Inc.	5527
Swoosh Technologies	5338
The Joseph Freedman Co Inc	1772
Tooling U-SME	1164
TribalVision	327
VJ Technologies Inc	5835

Contract Assembly

Acorn Industrial Products Co	5415
Air Inc	3039
Alpha Additive Manufacturing Technologies	5615
Dorsey Metrology International Inc	3119
ECM Global Measurement Solutions	3008
Faxon Engineering	1768
GKS Lifting and Moving Solutions LLC	3325
Hygrade Precision Technologies	5566
Kalow Technologies	5821
Lynn Welding	2027
Minuteman / Empire Automation Systems	3301
Pauway Corp	5549
Pearse-Bertram LLC	3245
Winslow Engineering Inc	2109

Contract Inspection

Accurex Measurement Inc	3139
Capture 3D Inc	3044
ECM Global Measurement Solutions	3008
Hexagon Manufacturing Intelligence	3103
Holts Precision Inc	3156, 5419
J & L Metrology Inc	3255
Johnson Gage Co	3042
Kalow Technologies	5821
L.F.O'leary Co.Inc/ Glastonbury Southern Gage	3254
Nikon Metrology Inc	3203
Perry Technology Corp	5623
Pratt & Whitney Measurement Systems Inc	3006
Precision Jig Fixture & Metrology	5831
Proto Labs Inc	5752
Quality Plus Inc	3241
Wenzel America Ltd	3223
Werth Inc	3213
Winslow Engineering Inc	2109
ZEISS Industrial Metrology	3159

Contract Machining

Advanced Machine & Engineering	5843
Aerospace Alloys Inc	5729
Alpha Grainger Manufacturing	5683
Conley Casting Supply Corp	5739
Dorsey Metrology International Inc	3119
Edac Technologies	5553
Electrodes Inc	1128
Front Panel Express	5568
Hawkeye Innovation LLC	5838
HPM Technologie GmbH	5765
Hygrade Precision Technologies	5566
JH Robotics Inc	1462
Laroche Foundry Ltd	5362
Lynn Welding	2027
Mach 1 Systems Inc	1725
Millinocket Fabrication & Machine LLC	2126
Nagel Precision Inc	5850
Perry Technology Corp	5623
Peterson Steel Corp	5558
Plastics International	5366
Precision Jig Fixture & Metrology	5831
Precision Laser Technology LLC	3154
Precision Punch Corp	5633
Preco Inc	5237
Proto Labs Inc	5752
Ram Precision Tool Inc	1626
Saturn Industries Inc	1237
TCl Precision Metals	5030
The Joseph Freedman Co Inc	1772
Yamazen Inc	1005

**Contract Manufacturing
Services**

Acorn Industrial Products Co	5415
Advance Welding	5870
Advanced Machine & Engineering	5843
Aerospace Alloys Inc	5729
Alpha Grainger Manufacturing	5683
Aquajet Cutting Technology	1654
Automation Engineering Co	5759
Dapra Marking Systems	2037
Dorsey Metrology International Inc	3119
Edac Technologies	5553
Front Panel Express	5568
GH Induction Atmospheres LLC	2033
Hawkeye Innovation LLC	5838
Hygrade Precision Technologies	5566
J & L Metrology Inc	3255
Kalow Technologies	5821
Laroche Foundry Ltd	5362
Laser Measuring Technologies LLC	3122
Lynn Welding	2027
Mach 1 Systems Inc	1725
Millinocket Fabrication & Machine LLC	2126
Minuteman / Empire Automation Systems	3301
Pauway Corp	5549
Pearse-Bertram LLC	3245
Perry Technology Corp	5623
Plastics International	5366
Precision Laser Technology LLC	3154
Preco Inc	5237
Proto Labs Inc	5752
Ram Precision Tool Inc	1626
Sanken Industry Co. Ltd.	5749
Solar Atmospheres	1251
TCl Precision Metals	5030
Vision Engineering Inc	3322
Yamazen Inc	1005

Controls

Antaira	3145
Axis New England	3328
Babin Machine Tool	1743
Conley Casting Supply Corp	5739
Copley Controls	3328
CPU Automation Inc	3145
Elm Electrical	1852
Fagor Automation Corp	1623
Heidenhain Corp	1134
Hiwin Corporation	3034
Mitsubishi Electric Automation Inc	1140
Omron	3328
Pearse-Bertram LLC	3245
Quality Vision International	3003
Rice Machinery Inc	1734
Sanyo Denki	3145
Siemens Industry Inc	2012
Syil America Inc	1808
Syntec Technology Inc	5130
The Hope Group	5858
Two Technologies Inc	3326
Unitronics	3145
Walker Magnetics	5543

**Conveyors & Conveying
Systems**

Air Filtration Systems	3059
Air Inc	3039
Airline Hydraulics Corp	1820
Ajax Tocco Magnethermic Corp	1026
Amada Machine Tools America	1754
Amada Marvel Inc	2114
Automation Engineering Co	5759
Deluxe Systems	3340
Dorner Mfg	5523
Elm Electrical	1852
Ergotronix Inc	5144
Gibson Engineering Co Inc	3045
HEM Inc	2038
JH Robotics Inc	1462
Jorgensen Conveyors, Inc.	5759
Kalow Technologies	5821
LS Industries Inc	3043
Mayfran	5469
Mikro Industrial Finishing Co	5440
Minuteman / Empire Automation Systems	3301
Paletti USA	3239
Stamptech Inc	5523
Star CNC Machine Tool Corp / Eurotech Elite	1444
Takachiho America Inc.	5741
Taylor-Winfield Technologies Inc	2107
Vention	329
Wickman Machine Tool Inc	1822

Coolants & Lubricants

Action Bearing Co	5514
Amada Machine Tools America	1754
ATAGO USA Inc	5745
BlackHawk / Kennametal	5563
Blaser Swisslube Inc	5648
Blaser-Swisslube	1118
Butler Bros	5637
Carbide Related Technologies, Inc.	5765
Chemetal US Inc	3234
Custom Service Solutions Inc	3218
Dennison Lubricants	5662
DoALL Sawing Products	2133

Doringer Cold Saws	2035
DuBois Chemicals Inc	5449
EM Benson Co	5141
Fastenal Company	5575
Hangsterfer's Laboratories Inc	5632
HEM Inc	2038
Houghton International Inc	5560
HPM Technologie GmbH	5765
Keller Products Inc	3057
Lubrication Technologies Inc	5737
MCRL Inc / Fluid Chillers	1001
Modern Tools Inc	1127
Shell Lubricants	5662
SpiderCool	1241
Summit	5662
Sunnen Products Co	2111
Turpin Sales & Marketing Inc	5570
Unist	5523
US Shop Tools	5609

Coolers & Chillers Non-Welding

Aimtek Inc	2108
Aquajet Cutting Technology	1654
Ebbco Inc	1727
Eclipse Magnetics	3022
Fluid Chillers	1001
MCRL Inc / Fluid Chillers	1001
Rittal Corp	5035
Star CNC Machine Tool Corp / Eurotech Elite	1444
The Robert E. Morris Company	5464
Walrus America Inc	5748

Curing Ovens & Equipment

Ajax Tocco Magnethermic Corp	1026
Blast & Wash Systems	5509
Hardline Heat Treating Inc	2011
Lucifer Furnaces Inc	2003
Noble Industrial Furnace	3354
Pauway Corp	5549
Purex Inc	2102
Radyne Corp	1102

Cutting Fluids & Lubricants

Amada Machine Tools America	1754
ATAGO USA Inc	5745
Blaser Swisslube Inc	5648
Blaser-Swisslube	1118
Carbide Related Technologies, Inc.	5765
Chemetall US Inc	3234
Dennison Lubricants	5662
DoALL Sawing Products	2133
DuBois Chemicals Inc	5449
Electrodes Inc	1128
EM Benson Co	5141
Eureka Chemical Co	3243
Fastenal Company	5575
Genevieve Swiss Industries Inc	5133
Hangsterfer's Laboratories Inc	5632
HEM Inc	2038
Houghton International Inc	5560
HPM Technologie GmbH	5765
Keller Products Inc	3057
Lindco Springfield Co	1118
Shell Lubricants	5662
SpiderCool	1241
Summit	5662
Unist	5523

Cutting Machines, Sheet & Plate Lasers

Airgas	1656
Boston Laser Tech	5722
Carlson Fabrication Solutions	2128
Chapin & Bangs Steel Co / Lindquist Steels Inc	5012
Cincinnati Inc	1844
Jinan Bodor CNC Machine Co Ltd	1146
LaserStar Technologies Corp	2100
Machitech Automation	1656
Mitsubishi EDM / MC Machinery Systems Inc	1426
Multicam East	1035
Northeast Machinery Sales/FlexCNC	1228
Preco Inc	5237
Purex Inc	2102
Rollomatic Inc	1706
SISMA USA Inc	2104
TRUMPF Inc	2004
Vance Metal Fabricators Inc	1824
Vytek Laser Systems	2022

Cutting Machines, Sheet & Plate Plasma

Airgas	1656
Cincinnati Inc	1844
Machitech Automation	1656
Multicam East	1035
Northeast Machinery Sales/FlexCNC	1228
Praxair Distribution Inc.	1606
Preco Inc	5237
Purex Inc	2102
Vance Metal Fabricators Inc	1824

Cutting Machines, Sheet & Plate Waterjet

Aerospace Alloys Inc	5729
Airgas	1656
Aquajet Cutting Technology	1654
Carlson Fabrication Solutions	2128
Flow International Corp	1712
Hypertherm	5743
Jet Edge	1770
KMT Waterjet Systems Inc	1344
Machitech Automation	1656
Multicam East	1035
Northeast Machinery Sales/FlexCNC	1228
OMAX Corp	1106
Praxair Distribution Inc.	1606
Preco Inc	5237
Stratus Technologies	5743

Cutting Tools High-Speed Steel

Allied Machine & Engineering	5453
Aloris Tool Technology Co Inc	5332
ANCA Inc	1244
ARCH Cutting Tools & Beamer Laser Marking Systems	5666
Big Kaiser Precision Tooling Inc	5248
BlackHawk / Kennametal	5563
Controx Inc	5571
Cutler Industrial Sales	5469
Darex LLC	5676
Diacut Inc	3226

Emuge Corp	5369
Everede Tool Company	5649
Fastenal Company	5575
Gebr. Saacke GmbH & Co. KG	1156
Guhring Inc	5333
Hassay Savage Co	5774
iSwiss Corporation	5616
Kyocera Precision Tools Inc	5573
Lexington Cutter	5469
Link Industries	5826
LMT Onsrud Tooling	1035
Mapal Inc	5327
Martindale Electric Co	5719
Maxtool Corp.	5002
Melin Tool Company	5618
Mikron Corp Monroe	5426
Mitsubishi Materials USA	5468
OG Bell Co	5767
OSG USA INC	5652
Somma Tool Co	5542
Starrett Company	3011, 5045
THINBIT	5348
Tru Tech Systems Inc	1830
US Tool Group Inc	5626
Vollmer Of America	1158
YG-1 Tool Co	5474

Cutting Tools Polycrystalline CBN & Diamond

Anca Inc	1244
Belmont Equipment & Technologies	1248
BlackHawk / Kennametal	5563
Butler Bros	5637
Ceratizit	1118
Contour360	5559
Diacut Inc	3226
Electrodes Inc	1128
EM Benson Co	5141
Emuge Corp	5369
Everede Tool Company	5649
Fullerton Tool Co	5736
Guhring Inc	5333
GWS Tool Group	5621
GWS/Benchmark Carbide	1118
Horn Usa Inc	5353
Internal Tool	5853
Kyocera Precision Tools Inc	5573
Lindco Springfield Co	1118
LMT Onsrud Tooling	1035
Lovejoy Tool Co	5242
Mapal Inc	5327
Maxtool Corp.	5002
Mikron Corp Monroe	5426
Mitsubishi Materials USA	5468
Multicam East	1035
NTK Cutting Tools	5564
OSG Usa Inc	5652
Radiac Abrasives	1118
Scientific Cutting Tools Inc	5224
Simtek Usa Inc.	5636
Starrett Company	3011, 5045
Sunnen Products Co	2111
THINBIT	5348
Tool-Flo Manufacturing Inc	5519
Tru Tech Systems Inc	1830
Vollmer Of America	1158
YG-1	1118
YG-1 Tool Co	5474

Cutting Tools Carbide

Allied Machine & Engineering	5453
Aloris Tool Technology Co Inc	5332
Alpha Grainger Manufacturing	5683
ANCA Inc	1244
ARCH Cutting Tools & Beamer Laser Marking Systems	5666
Big Kaiser Precision Tooling Inc	5248
BlackHawk / Kennametal	5563
Butler Bros	5637
Carbide Grinding Co Inc	5341
Carbide Related Technologies, Inc.	5765
Carmex Precision Tools LLC	5016
Ceratizit	1118
Contour360	5559
Controx Inc	5571
Cutler Industrial Sales	5469
Darex LLC	5676
Diacut Inc	3226
EM Benson Co	5141
Emuge Corp	5369
Everede Tool Company	5649
Fastenal Company	5575
Fullerton Tool Co	5736
Gebr. Saacke GmbH & Co. KG	1156
Genevieve Swiss Industries Inc	5133
Gesswein Co	5653
Greenleaf Corp	5317
Guhring Inc	5333
GWS Tool Group	5621
GWS/Benchmark Carbide	1118
Haimer USA	5458
Hassay Savage Co	5774
Heule Precision Tools	5385
HORN USA Inc	5353
Internal Tool	5853
JM Performance Products Inc	5422
Kyocera Precision Tools Inc	5573
Laser Measuring Technologies LLC	3122
Lexington Cutter	5469
Lindco Springfield Co	1118
Link Industries	5826
LMT Onsrud Tooling	1035
Lovejoy Tool Co	5242
Mapal Inc	5327
Martindale Electric Co	5719
Maxtool Corp.	5002
Melin Tool Company	5618
Mikron Corp Monroe	5426
Mitsubishi Materials USA	5468
Monster Tool Co Inc	5411
Multicam East	1035
Nexgen Tooling	5747
NTK Cutting Tools	5564
OG Bell Co	5767
OSG Usa Inc	5652
ReCarb LLC	5642
Sandvik Coromant	1118
Scientific Cutting Tools Inc	5224
SIMTEK USA Inc.	5636
Somma Tool Co	5542
Southwick & Meister Inc	5387
Starrett Company	3011, 5045
Sunnen Products Co	2111
THINBIT	5348
Tool-Flo Manufacturing Inc	5519
Tru Tech Systems Inc	1830
Turpin Sales & Marketing Inc	5570
US Shop Tools	5609
US Tool Group Inc	5626
Vollmer Of America	1158
Wickman Machine Tool Inc	1822
YG-1	1118
YG-1 Tool Co	5474

Cutting Tools Ceramic

ANCA Inc	1244
BlackHawk / Kennametal	5563
Butler Bros	5637
Carbide Related Technologies, Inc.	5765
Ceratizit	1118
Diacut Inc	3226
Gesswein Co	5653
Greenleaf Corp	5317
Guhring Inc	5333
GWS Tool Group	5621
HORN USA Inc	5353
Internal Tool	5853
Kyocera Precision Tools Inc	5573
Lindco Springfield Co	1118
LMT Onsrud Tooling	1035
Lovejoy Tool Co	5242
MAPAL Inc	5327
Mitsubishi Materials USA	5468
NTK Cutting Tools	5564
Sandvik Coromant	1118
Tool-Flo Manufacturing Inc	5519
Tru Tech Systems Inc	1830

Cybersecurity

Antaira	3145
Moxa	3328

Data Collection Systems

Bruker Corporation	3026
Caron Engineering Inc	5432
Chemetall US Inc	3234
CPU Automation Inc	3145
Dino-Lite Scopes (BigC)	3143
Dynics Inc.	3145
Flexbar Machine Corp	3157
Fowler High Precision Inc	3251
Gibson Engineering Co Inc	3045
Glastonbury Southern Gage Thread & Cylindrical Gages And Masters	3254
GTI Spindle Technology Inc	5562
Heidenhain Corp	1634
Hexagon Manufacturing Intelligence	3103
High QA, Inc	341
Holts Precision Inc	3156, 5419
Judge Tool & Gage	3138
Keyence Corp of America	2042
Kotem	3003
L.F.O'leary Co.Inc./ Glastonbury Southern Gage	3254
Macdac Engineering	5233
Marposs Corp	1644
Metrologic Group Services	3228
Mitutoyo America Corp	3111
Nexas America LLC	5527
Nikon Metrology Inc	3203
Nysus Solutions LLC	3259
OASIS Inspection Systems	3050
Pinpoint Laser Systems	3054
Pratt & Whitney Measurement Systems Inc	3006
Scytec Consulting Inc.	5527
ShopFloorConnect	5668
Starrett Company	3011, 5045
Thermo Fisher Scientific	339
VKS - Visual Knowledge Share	5370

Deburring Machines

Air Turbine Tools	5753
Blast & Wash Systems	5509
Blast it All	5509
Burr King Manufacturing Co	1713
Carlson Fabrication Solutions	2128
Comco Inc	5545
Cutler Industrial Sales	5469
Ecoclean Inc	3019
EMAG LLC	1045
Force Automation	5509
Gibson Abrasive Equipment	5509
LS Industries Inc	3043
Midwest Automation	1228
Mikro Industrial Finishing Co	5440
Nagel Precision Inc	5850
New England Metal Finishing & Precision Finishing Services	5136
New England Sales Inc	2026
Northeast Machinery Sales/FlexCNC	1228
NSK America Corp	5344
Somma Tool Co	5542
Vapor Honing Technologies	5509
Wickman Machine Tool Inc	1822

Deep Hole (Gundrilling) Machines (Special Machines)

Advanced Machine & Engineering	5843
Aloris Tool Technology Co Inc	5332
Automation Engineering Co	5759
Edac Technologies	5553
Kays Engineering/DeHoff/Eldorado	1612
Nagel Precision Inc	5850
Suhner Industrial Products Inc	5020
Sunnen Products Co	2111
Takachiho America Inc.	5741
UNISIG	1235

Design Simulation

AutoForm Engineering USA Inc	5467
Swoosh Technologies	5338

Dies & Die Components

Aloris Tool Technology Co Inc	5332
HASCO America Inc.	5010
Precision Punch Corp	5633
Tapeswitch Corporation	336

Dies Stamping & Forming

Monode	5682
Numberall Stamp & Tool Co	1142
Precision Punch Corp	5633
Tapeswitch Corporation	336
W & H Stampings & Fineblanking	5550

Digital Gages

Digipas Technologies Inc	5340
Dorsey Metrology International Inc	3119
Fischer Technology Inc	5738
Fowler High Precision Inc	3251
Heidenhain Corp	1634
Holts Precision Inc	3156, 5419
J & L Metrology Inc	3255

Johnson Gage Co	3042
Judge Tool & Gage	3138
Marposs Corp	1644
Mitutoyo America Corp	3111
New Scale Robotics	2139
Omni Services	5612
Pratt & Whitney	
Measurement Systems Inc	3006
Precision Jig Fixture & Metrology	5831
Quality Plus Inc	3241
Starrett Company	3011, 5045
Thermo Fisher Scientific	339
Verisurf Software Inc	5050

Digital Transformation

LillyWorks Scheduling & ERP Software	5763
Macdac Engineering	5233
MachineMetrics	5037
Makino Inc	1236
Nexas America LLC	5527
Scytec Consulting Inc.	5527
ShopFloorConnect	5668
Swoosh Technologies	5338

Digitizers

Capture 3D Inc	3044
Renishaw Inc	3151

DNC

CIMCO Americas LLC	5716
Fagor Automation Corp	2123
Griffo Brothers Inc	5034
Macdac Engineering	5233
Nexas America LLC	5527
WireFreeCNC	5233

Drafting & Designing Services

Air Inc	3039
Cimquest Inc	5036
Dorsey Metrology International Inc	3119
G II Solutions Inc	1253
Hawkeye Innovation LLC	5838
item Northeast	1861
Kalow Technologies	5821
Paletti USA	3239
Sanken Industry Co. Ltd.	5749
Winslow Engineering Inc	2109

Drilling & Reaming Tools

Allied Machine & Engineering	5453
ANCA Inc	1244
ARCH Cutting Tools & Beamer Laser Marking Systems	5666
Big Kaiser Precision Tooling Inc	5248
BlackHawk / Kennametal	5563
Butler Bros	5637
Carbide Related Technologies, Inc.	5765
Carmex Precision Tools LLC	5016
Ceratzit	1118
Contour360	5559
Cutler Industrial Sales	5469
Darex LLC	5676
Evered Tool Company	5649
Fastenal Company	5575

Fullerton Tool Co	5736
Genevieve Swiss Industries Inc	5133
Guhring Inc	5333
GWS Tool Group	5621
GWS/Benchmark Carbide	1118
Hassay Savage Co	5774
Internal Tool	5853
iSwiss Corporation	5616
Kays Engineering/DeHoff/Eldorado	1612
Kyocera Precision Tools Inc	5573
Laser Measuring Technologies LLC	3122
Lexington Cutter	5469
Lindco Springfield Co	1118
Link Industries	5826
MAPAL Inc	5327
Maxtool Corp.	5002
Melin Tool Company	5618
Mikron Corp Monroe	5426
Mitsubishi Materials USA	5468
Nagel Precision Inc	5850
Nexgen Tooling	5747
OG Bell Co	5767
OSG USA INC	5652
ReCarb LLC	5642
Sandvik Coromant	1118
Sunnen Products Co	2111
Turpin Sales & Marketing Inc	5570
US Tool Group Inc	5626
Vollmer Of America	1158
YG-1	1118
YG-1 Tool Co	5474

Drilling & Tapping Equipment

Air Turbine Tools	5753
Automation Engineering Co	5759
Centaur Precision Tools Inc	5512
Cutler Industrial Sales	5469
Dake	5469
Datron Dynamics Inc	5240
FlexArm Inc	5541
FlexCNC	1228
GF Machining Solutions	1620
Haas Factory Outlet - Trident	1218
Hypneumat/Commander/Snow	5759
KAASST Machine Tools Inc	2134
Mikron Corp Monroe	5426
Sauter North America Inc	5423
Sir Meccanica SpA	5445
Somma Tool Co	5542
SpiderCool	1241
Sugino Corp.	5759
Suhner Industrial Products Inc	5020
Sunnen Products Co	2111
Syil America Inc	1808
Yamazen Inc	1005
Yuasa International	1748

DROs (Digital Readouts)

Babin Machine Tool	1743
Fagor Automation Corp	2123
Heidenhain Corp	1634
Judge Tool & Gage	3138
Mitutoyo America Corp	3111
Rice Machinery Inc	1734
Verisurf Software Inc	5050

EDM Machines

Alpha Grainger Manufacturing	5683
Belmont Equipment & Technologies	1248
Belmont Equipment and Technologies	1620
Brooks Assoc Inc	1206
Current EDM Inc	1255
Ebbco Inc	1727
EDM Network Inc	1648
Electrodes Inc	1128
Fluid Chillers	1001
GF Machining Solutions	1420, 1620
KAASST Machine Tools Inc	2134
Kgk International Corp	1662
Makino Inc	1236
Methods Machine Tools Inc	2034
Mitsubishi EDM /	
MC Machinery Systems Inc	1426
Perry Technology Corp	5623
Ram Precision Tool Inc	1626
Ross Machinery Sales Inc	1620

EDM Supplies and Accessories

Belmont Equipment & Technologies	1248
Belmont Equipment and Technologies	1620
Carr Lane Manufacturing/ Carr Lane Roemheld	5659
Current EDM Inc	1255
Ebbco Inc	1727
EDM Network Inc	1648
Electrodes Inc	1128
General Manufacturing Inc	1863
GF Machining Solutions	1420, 1620
Hangsterfer's Laboratories Inc	5632
Hirschmann Engineering USA Inc	1231
Mitsubishi EDM /	
MC Machinery Systems Inc	1426
OC White CO	3051
Ram Precision Tool Inc	1626
Ross Machinery Sales Inc	1620
Saturn Industries Inc	1237
Takachiho America Inc.	5741
Turpin Sales & Marketing Inc	5570
Waldmann Lighting Co	1614

EDM Tooling & Fixtures

Belmont Equipment & Technologies	1248
Belmont Equipment and Technologies	1620
Carr Lane Manufacturing/ Carr Lane Roemheld	5659
Chumpower Machinery Corp	5770
Current EDM Inc	1255
EDM Network Inc	1648
Electrodes Inc	1128
GF Machining Solutions	1620
Hermann Schmidt Co	1723
Hirschmann Engineering USA Inc	1231
Makino Inc	1236
Methods Machine Tools Inc	2034
Ram Precision Tool Inc	1626
Saturn Industries Inc	1237

Education & Training Services & Institutions

American Society of Mechanical Engineers	5751
Boston Tooling and Machining Association sponsored by CompuMachine	5245
Conley Casting Supply Corp	5739

ECM Global Measurement Solutions	3008
LaserStar Technologies Corp	2100
Lubrication Technologies Inc	5737
Mitsubishi Materials USA	5468
Mitutoyo America Corp	3111
Nikon Metrology Inc	3203
NTMA	1862
Plastics International	5366
Poco Graphite	1227
Siemens Industry Inc	2012
SME	1164
SME Education Foundation	1164
SME Media	1164
Swoosh Technologies	5338
Syil America Inc	1808
The Custom Group Center	
For Manufacturing Technology	5582
Tooling U-SME	1164
Wickman Machine Tool Inc	1822

Electronics Assembly

Kalow Technologies	5821
Purex Inc	2102

Engineering Services

Airline Hydraulics Corp	1820
American Society of Mechanical Engineers	5751
Aquest Corp	3347
Buffoli North America	2041
CIMCO Americas LLC	5716
ECM Global Measurement Solutions	3008
Ecoclean Inc	3019
Faxon Engineering	1768
G II Solutions Inc	1253
Hawkeye Innovation LLC	5838
JH Robotics Inc	1462
Kalow Technologies	5821
Perry Technology Corp	5623
R & D Technologies	5776
Swoosh Technologies	5338
The Hope Group	5858
VJ Technologies Inc	5835
Winslow Engineering Inc	2109

Engraving Equipment

Air Turbine Tools	5753
Amada Miyachi America	2101
Boston Laser Tech	5722
Datron Dynamics Inc	5240
Epilog Laser Corp	2129
Gesswein Co	5653
Keyence Corp of America	3029
LaserStar Technologies Corp	2100
MB Metal Technologies LLC	2009
Monode	5682
Multicam East	1035
Numberall Stamp & Tool Co	1142
Precision Laser Technology LLC	3154
TYKMA Electro	3035

Environmental Equipment & Protection

AER Control Systems LLC	5762
Air Filtration Systems	3059
Airflow Systems Inc	3309
Aquest Corp	3347

Blast & Wash Systems	5509
Custom Service Solutions Inc	3218
Diversitech Air Filtration	5509
Ebbco Inc	1727
EXM	3145
Hangsterfer's Laboratories Inc	5632
Ketcham & Co Inc	3306
Nordfab Ducting	3025
Pro Ultrasonics	3055
Purex Inc	2102
SciAps Inc	3125

Ergonomics

Airline Hydraulics Corp	1820
Ergo Advantage	5617
Ergotron Inc	5144
EXM	3145
FlexArm Inc	5541
item Northeast	1861
Modula Inc	1254
NSK America Corp	5344
Stamptech Inc	5523
Vision Engineering Inc	3322
Waldmann Lighting Co	1614
Workplace Modular Systems LLC	5658

Fabricated Components

Acorn Industrial Products Co	5415
Automation Engineering Co	5759
Curbell Plastics Inc	5771
Inter-Lakes Bases, Inc.	5759
Laroche Foundry Ltd	5362
Millinocket Fabrication & Machine LLC	2126
VJ Technologies Inc	5835

Fabricating

Acorn Industrial Products Co	5415
Advance Welding	5870
Aerospace Alloys Inc	5729
Automation Engineering Co	5759
BUWW Coverings Inc	3335
Fabricating & Metalworking Magazine	3321
Front Panel Express	5568
HEM Inc	2038
Inter-Lakes Bases, Inc.	5759
Machitech Automation	1656
Millinocket Fabrication & Machine LLC	2126
Mitsubishi EDM / MC Machinery Systems Inc	1426
Supra Alloys A Div of TITAN	
Metal Fabricators Inc	5643
Vance Metal Fabricators Inc	1824

Fans & Blowers

Air Filtration Systems	3059
Airflow Systems Inc	3309
Aquest Corp	3347
EXM	3145
Harvey Industries International Inc	3343
Ketcham & Co Inc	3306
OC White CO	3051
Rittal Corp	5035
Ventilation USA LLC	3018

Fasteners & Precision Formed Parts

Arnold Supply Inc	5548
Fixtureworks	5766
Paletti USA	3239
TCI Precision Metals	5030

Fastening & Joining Equipment

Aimtek Inc	2108
Ambrell Induction Heating Solutions	2008
Atlas Copco Tools/Palmac	1134
CGTech	5350
EMAG LLC	1045
Judge Tool & Gage	3138
LaserStar Technologies Corp	2100
Radyne Corp	1102
Vlier Products	5526

Files New & Resharpener

BlackHawk / Kennametal	5563
Martindale Electric Co	5719

Filters & Filtration

Advanced Machine & Engineering	5843
Advanced Superabrasives, Inc.	1156
AER Control Systems LLC	5762
Air Filtration Systems	3059
Air Inc	3039
Aquajet Cutting Technology	1654
Aquest Corp	3347
Automation Engineering Co	5759
Blast & Wash Systems	5509
Custom Service Solutions Inc	3218
Ebbco Inc	1727
Eclipse Magnetics	3022
Electrodes Inc	1128
Faxon Engineering	1768
Hangsterfer's Laboratories Inc	5632
Jorgensen Conveyors, Inc.	5759
Keller Products Inc	3057
Ketcham & Co Inc	3306
Lubrication Technologies Inc	5737
MCRL Inc / Fluid Chillers	1001
Mikro Industrial Finishing Co	5440
Minuteman / Empire Automation Systems	3301
New England Metal Finishing	
& Precision Finishing Services	5136
Nordfab Ducting	3025
Parker	5858
Rosedale Products Inc	3028
Royal Products	5469
Rush Machinery	1129
Saturn Industries Inc	1237
Star CNC Machine Tool Corp / Eurotech Elite	1444
Takachiho America Inc.	5741
The Hope Group	5858
Tru Tech Systems Inc	1830

Finishing & Coating

Advanced Coating Service	5624
Ajax Tocco Magnethermic Corp	1026
Alexandria Metal Finishers	5742
Anoplate Corp	5726

Armology of Connecticut Inc	5246
Chemetall US Inc	3234
DuBois Chemicals Inc	5449
Garboli	5820
J&S Machine Inc	5820
Northeast Coating Technologies	5540
Pauway Corp	5549
Rock Ridge Abrasives	5743
Smith & Wesson Precision Components	5365

Finishing Plating & Coating Equipment & Systems

Aimtek Inc	2108
Chemetall US Inc	3234
DuBois Chemicals Inc	5449
Noble Industrial Furnace	3354
Oerlikon Balzers Coating USA Inc	5567
Pauway Corp	5549
Purex Inc	2102

Fixtures & Components

ABTech Inc	3012
Advanced Machine & Engineering	5843
Belmont Equipment & Technologies	1248
Big Kaiser Precision Tooling Inc	5248
Blue Photon Technology & Workholding Systems LLC	5734
Carr Lane Manufacturing/ Carr Lane Roemheld	5659
Erowa Technology Inc	1628
Fixtureworks	5766
General Manufacturing Inc	1863
Halder Inc	5427
Hawkeye Innovation LLC	5838
Hirschmann Engineering USA Inc	1231
Jergens Inc	5644
Kitagawa-NorthTech Inc.	1152
L.F.OiLeary Co.Inc/ Glastonbury Southern Gage	3254
Lang Technovation Co	5483
Mitee-Bite Products LLC	5459
Modern Industries Inc	5750
New England Metal Finishing & Precision Finishing Services	5136
Northfield Precision Instrument Corp	5508
Paletti USA	3239
PAWS Workholding	5866
Phillips Precision Inc	3342
Plastics International	5366
Precision Jig Fixture & Metrology	5831
R&R Fixtures LLC	3318
Ram Precision Tool Inc	1626
Renishaw Inc	3151
Samchully Workholding	5469
SMW Autoblok Corp	2013
Strong Hand Tools	5627
TE-CO	5463
TRIAG	5843
Vektak LLC	5026
Vlier Products	5526
Waldmann Lighting Co	1614
ZEISS Industrial Metrology	3159

Flexible Manufacturing Systems (FMS) Equipment & Software

Buffoli North America	2041
GF Machining Solutions	1620
Mitsui Seiki USA	1620
Racer Machinery International Inc	1638
Ross Machinery Sales Inc	1620
Toyoda Americas Corporation	1034
Yamazen Inc	1005

Fluid Power Components

Advanced Machine & Engineering	5843
Air Inc	3039
Airline Hydraulics Corp	1820
Carr Lane Manufacturing/ Carr Lane Roemheld	5659
Faxon Engineering	1768
Houghton International Inc	5560
Lubrication Technologies Inc	5737
Minuteman / Empire Automation Systems	3301
Omni Services	5612
Parker	5858
Roemheld	5661
The Hope Group	5858
Walrus America Inc	5748

Forging Equipment

Ajax Tocco Magnethermic Corp	1026
GH Induction Atmospheres LLC	2033
Lucifer Furnaces Inc	2003

Forming & Fabricating

Advance Welding	5870
Carlson Fabrication Solutions	2128
Cincinnati Inc	1844
CLOMEA / 3C	5820
Flow International Corp	1712
GH Induction Atmospheres LLC	2033
J&S Machine Inc	5820
KAAST Machine Tools Inc	2134
Laroche Foundry Ltd	5362
Lucifer Furnaces Inc	2003
Millinocket Fabrication & Machine LLC	2126
Mitsubishi EDM / MC Machinery Systems Inc	1426
Northeast Machinery Sales/FlexCNC	1228
Penn Stainless Products Inc	5043
Praxair Distribution Inc.	1606
Proto Labs Inc	5752
Radyne Corp	1102
Sanken Industry Co. Ltd.	5749
SIMASV	5820
Somma Tool Co	5542
Strong Hand Tools	5627
Tapeswitch Corporation	336
TRUMPF Inc	2004
Vance Metal Fabricators Inc	1824

Foundry Equipment & Supplies

Ajax Tocco Magnethermic Corp	1026
Blast & Wash Systems	5509
Conley Casting Supply Corp	5739
GKS Lifting and Moving Solutions LLC	3325
Noble Industrial Furnace	3354
VJ Technologies Inc	5835

Furnaces

Ajax Tocco Magnethermic Corp	1026
Ambrell Induction Heating Solutions	2008
GH Induction Atmospheres LLC	2033
Noble Industrial Furnace	3354
Radyne Corp	1102
Ultraflex Power Technologies Corp	1138

Gages & Gaging Systems

Accurex Measurement Inc	3139
Airline Hydraulics Corp	1820
Control Gaging Inc	3224
Digipas Technologies Inc	5340
Dorsey Metrology International Inc	3119
Faxon Engineering	1768
Fowler High Precision Inc	3251
Heidenhain Corp	1634
Holts Precision Inc	3156, 5419
J & L Metrology Inc	3255
JH Robotics Inc	1462
Johnson Gage Co	3042
Judge Tool & Gage	3138
Marposs Corp	1644
Mitutoyo America Corp	3111
New Scale Robotics	2139
Omni Services	5612
Origin Technologies Corp	1854
Pinpoint Laser Systems	3054
Pratt & Whitney Measurement Systems Inc	3006
Precision Jig Fixture & Metrology	5831
Quality Plus Inc	3241
Renishaw Inc	3151
Starrett Company	3011, 5045
Sunnen Products Co	2111
Thermo Fisher Scientific	339
Verisurf	5036
Verisurf Software Inc	5050
Yuasa International	1748

Gaskets Seals & Washers

Action Bearing Co	5514
American Society of Mechanical Engineers	5751
Curbell Plastics Inc	5771
Omni Services	5612

Gear Cutting Forming & Finishing Machines

EM Benson Co	5141
EMAG LLC	1045
Engis Corp	5028
Gebr. Saacke GmbH & Co. KG	1156
Haas Multigrind	1051
Perry Technology Corp	5623
Saacke North America LLC	1156
Toyoda Americas Corporation	1034

Gears & Splines

EM Benson Co	5141
Laroche Foundry Ltd	5362
Millinocket Fabrication & Machine LLC	2126
Perry Technology Corp	5623
Turpin Sales & Marketing Inc	5570
WTO USA	5223

Grinder Accessories

Amada Machine Tools America	1754
Atrump Machinery Inc	1762
Burr King Manufacturing Co	1713
Control Gaging Inc	3224
Cool Grind Technologies	1745
Diacut Inc	3226
Ebbco Inc	1727
Edac Technologies	5553
G II Solutions Inc	1253
General Manufacturing Inc	1863
Hardinge Inc	5444
Hermann Schmidt Co	1723
Laser Measuring Technologies LLC	3122
Marposs Corp	1644
MIDACO Corp	1858
Mirka / Cafro	1711
Modern Tools Inc	1127
NSK America Corp	5344
OC White CO	3051
Okamoto Corp	1044
Rollomatic Inc	1706
Rush Machinery	1129
Saacke North America LLC	1156
SMW Autoblok Corp	2013
SpiderCool	1241
Supertec Grinders	1620
Takachiho America Inc.	5741
Tru Tech Systems Inc	1830
TTB Engineering SA	1156
Vollmer Of America	1158
Waldmann Lighting Co	1614
Walker Magnetics	5543
Winslow Engineering Inc	2109

Grinders & Grinding Machines

ABTech Inc	3012
Acer Group	1705
Air Turbine Tools	5753
Amada Grinders	1620
Amada Machine Tools America	1754
ANCA Inc	1244
Atrump Machinery Inc	1762
Brooks Assoc Inc	1206
Burr King Manufacturing Co	1713
Control Gaging Inc	3224
Darex LLC	5676
DCM Tech Inc	1125
Ebbco Inc	1727
Edac Technologies	5553
EMAG LLC	1045
FlexArm Inc	5541
Fluid Chillers	1001
Gebr. Saacke GmbH & Co. KG	1156
Haas Multigrind	1051
Hardinge Inc	5444
INIRAM Precision Machine Tool Inc	1468
KAASST Machine Tools Inc	2134
Kgk International Corp	1662
Kitagawa-NorthTech Inc.	1152
Laser Measuring Technologies LLC	3122
Makino Inc	1236

Mirka / Cafro	1711
Modern Tools Inc	1127
NESSteel Inc	5033
Northfield Precision Instrument Corp	5508
Northland Tool & Electronics	5828
Okamoto Corp	1044
Penn Stainless Products Inc	5043
Perry Technology Corp	5623
Praxair Distribution Inc.	1606
Rice Machinery Inc	1734
Rollomatic Inc	1706
Ross Machinery Sales Inc	1620
Rush Machinery	1129
Saacke North America LLC	1156
Schutte Corp	1056
SpiderCool	1241
Supertec Grinders	1620
Toyoda Americas Corporation	1034
Tru Tech Systems Inc	1830
TTB Engineering SA	1156
Vollmer Of America	1158
Weima America Inc	335
Winslow Engineering Inc	2109

Grinding Wheels

A. TEC Diamond Co Ltd	5006
Advanced Superabrasives, Inc.	1156
Allied Machine & Engineering	5453
Cool Grind Technologies	1745
Diacut Inc	3226
Engis Corp	5028
Fastenco Company	5575
Lindco Springfield Co	1118
Maxtool Corp.	5002
Mirka / Cafro	1711
Modern Tools Inc	1127
Radiac Abrasives	1118
Rush Machinery	1129
Tru Tech Systems Inc	1830
Vollmer Of America	1158
Winslow Engineering Inc	2109
YG-1 Tool Co	5474

Grooving Tools

Advent Tool & Manufacturing Inc.	5469
Aloris Tool Technology Co Inc	5332
Big Kaiser Precision Tooling Inc	5248
BlackHawk / Kennametal	5563
Carmex Precision Tools LLC	5016
Ceratizit	1118
Controx Inc	5571
Diacut Inc	3226
Everede Tool Company	5649
Genevieve Swiss Industries Inc	5133
Greenleaf Corp	5317
Guhring Inc	5333
GWS Tool Group	5621
GWS/Benchmark Carbide	1118
Hassay Savage Co	5774
HORN USA Inc	5353
Internal Tool	5853
Kyocera Precision Tools Inc	5573
Lindco Springfield Co	1118
Mikron Corp Monroe	5426
Mitsubishi Materials USA	5468
NTK Cutting Tools	5564
OSG USA INC	5652
Sandvik Coromant	1118
Scientific Cutting Tools Inc	5224
SIMTEK USA Inc.	5636
Southwick & Meister Inc	5387

Thinbit	5348
Tool-Flo Manufacturing Inc	5519
Turpin Sales & Marketing Inc	5570

Hardness Testers

Fischer Technology Inc	5738
Flexbar Machine Corp	3157
Fowler High Precision Inc	3251
Glastonbury Southern Gage Thread & Cylindrical Gages And Masters	3254
Hardline Heat Treating Inc	2011
Holts Precision Inc	3156, 5419
Judge Tool & Gage	3138
L.F.O'Leary Co.Inc/ Glastonbury Southern Gage	3254
Mitutoyo America Corp	3111
Olympus America Inc	1766
Starrett Company	3011, 5045
Thermo Fisher Scientific	339

Hazardous Handling

GKS Lifting and Moving Solutions LLC	3325
SciAps Inc	3125

Heat Exchangers

American Society of Mechanical Engineers	5751
Ebbco Inc	1727
MCRL Inc / Fluid Chillers	1001
Ventilation USA LLC	3018

Heat Treating

Advance Welding	5870
Aerodynamics Inc	5482
Ajax Tocco Magnethermic Corp	1026
Aloris Tool Technology Co Inc	5332
Bonal Technologies Inc	1136
Cambridge Vacuum Engineering	5857
CEIA USA Induction Heating Systems	1243
DuBois Chemicals Inc	5449
GH Induction Atmospheres LLC	2033
Hardline Heat Treating Inc	2011
Lucifer Furnaces Inc	2003
Noble Industrial Furnace	3354
Oerlikon Balzers Coating USA Inc	5567
Preco Inc	5237
Radyne Corp	1102
Solar Atmospheres	1251
Taylor-Winfield Technologies Inc	2107

Heat Treating Hardening Systems

Ajax Tocco Magnethermic Corp	1026
Alpha Laser - US	2105
GH Induction Atmospheres LLC	2033
Hardline Heat Treating Inc	2011
Lucifer Furnaces Inc	2003
Noble Industrial Furnace	3354
Preco Inc	5237
Radyne Corp	1102
Taylor-Winfield Technologies Inc	2107

Hoists & Cranes

American Society of Mechanical Engineers	5751
Atlas Copco Tools/Palmarc	1134
Carr Lane Manufacturing/ Carr Lane Roemheld	5659
Deluxe Systems	3340
Fastenal Company	5575
FlexArm Inc	5541
GKS Lifting and Moving Solutions LLC	3325
Osaap America	1132
Tapeswitch Corporation	336

Honing

Brush Research Manufacturing Co	5608
Darex LLC	5676
Engis Corp	5028
Mirka / Cafro	1711
Nagel Precision Inc	5850
REGO-FIX Tool Corp	5320
Sunnen Products Co	2111
Takachiho America Inc.	5741
Vapor Honing Technologies	5509

Hydraulic Systems

Airline Hydraulics Corp	1820
Carr Lane Manufacturing/ Carr Lane Roemheld	5659
Faxon Engineering	1768
GKS Lifting and Moving Solutions LLC	3325
Laroche Foundry Ltd	5362
Omni Services	5612
Roemheld	5661
The Hope Group	5858
Walrus America Inc	5748

IIoT

Antaira	3145
ATAGO USA Inc	5745
Axis New England	3328
Caron Engineering Inc	5432
Dynics Inc.	3145
GF Machining Solutions	1420
LillyWorks Scheduling & ERP Software	5763
Macdac Engineering	5233
MachineMetrics	5037
Makino Inc	1236
Minuteman / Empire Automation Systems	3301
Moxa	3328
Nexas America LLC	5527
Parker	5858
Scytec Consulting Inc.	5527
ShopFloorConnect	5668
VKS - Visual Knowledge Share	5370

Induction Heating

Ajax Tocco Magnethermic Corp	1026
Alpha Laser - US	2105
Ambrell Induction Heating Solutions	2008
CEIA USA Induction Heating Systems	1243
Controx Inc	5571
Fluid Chillers	1001
GH Induction Atmospheres LLC	2033
Hardline Heat Treating Inc	2011
Lucifer Furnaces Inc	2003

Radyne Corp	1102
Smith & Wesson Precision Components	5365
Taylor-Winfield Technologies Inc	2107
Ultraflex Power Technologies Corp	1138

Inspection Systems & Equipment

4D Technology Corp	3211
ABTech Inc	3012
Accurex Measurement Inc	3139
ATAGO USA Inc	5745
Autodesk Inc	5326
Blum-Novotest, Inc.	5432
Bruker Corporation	3026
Capture 3D Inc	3044
Caron Engineering Inc	5432
Certified Comparator Products (CCP)	3003
Cimquest Inc	5036
Control Gaging Inc	3224
CPU Automation Inc	3145
Digipas Technologies Inc	5340
Dino-Lite Scopes (BigC)	3143
Dorsey Metrology International Inc	3119
ECM Global Measurement Solutions	3008
Euro-Tech Corp	5336
FARO Technologies Inc	3135
Fischer Technology Inc	5738
Fixtureworks	5766
Flexbar Machine Corp	3157
Fowler High Precision Inc	3251
Gibson Engineering Co Inc	3045
Glastonbury Southern Gage Thread & Cylindrical Gages And Masters	3254
Gradient Lens Corporation	3150
GTI Spindle Technology Inc	5562
Hawkeye Innovation LLC	5838
Heidenhain Corp	1634
Hemel Engineering Products Inc	3207
Hexagon Manufacturing Intelligence	3103
High QA, Inc	341
Holts Precision Inc	3156, 5419
InnovMetric Software Inc	3244
ITACA	3003
J & L Metrology Inc	3255
JH Robotics Inc	1462
JM Performance Products Inc	5422
Johnson Gage Co	3042
Judge Tool & Gage	3138
Keyence Corp of America	2042, 3029
Koma Precision Inc	5359
L.F.O'leary Co.Inc/ Glastonbury Southern Gage	3254
Laser Measuring Technologies LLC	3122
Marposs Corp	1644
Metrologic Group Services	3228
Metronor Inc	3127
Mitutoyo America Corp	3111
Nikon Metrology Inc	3203
North Coast Technical	1865
Nysus Solutions LLC	3259
OASIS Inspection Systems	3050
OC White CO	3051
Olympus America Inc	1766
Omega TMM Inc.	5127
Optical Gaging Products	3003
Origin Technologies Corp	1854
Perry Technology Corp	5623
Phillips Precision Inc	3342
Pinpoint Laser Systems	3054
Pratt & Whitney Measurement Systems Inc	3006
Precision Jig Fixture & Metrology	5831

Quality Plus Inc	3241
Quality Vision International	3003
R&R Fixtures LLC	3318
RAM	3003
Renishaw Inc	3151
Rigaku Analytical Devices	3319
Rollomatic Inc	1706
SciAps Inc	3125
ShapeGrabber 3D Scanners	3003
Starrett Company	3011, 5045
Sunnen Products Co	2111
TE-CO	5463
Teledyne Dalsa	3145
Thermo Fisher Scientific	339
Vela Instruments LLC	5842
Verisurf Software Inc	5050
Vision Engineering Inc	3322
Wenzel America Ltd	3223
Werth Inc	3213
Winslow Engineering Inc	2109
Yuasa International	1748
ZEISS Industrial Metrology	3159
Zoller Inc	5436

Jigs & Fixtures

Advance Welding	5870
Belmont Equipment & Technologies	1248
Blue Photon Technology & Workholding Systems LLC	5734
Carr Lane Manufacturing/ Carr Lane Roemheld	5659
Fixtureworks	5766
Halder Inc	5427
Jergens Inc	5644
Kitagawa-NorthTech Inc.	1152
L.F.O'leary Co.Inc/ Glastonbury Southern Gage	3254
Lang Technovation Co	5483
LaserStar Technologies Corp	2100
Mitee-Bite Products LLC	5459
New England Metal Finishing & Precision Finishing Services	5136
Northfield Precision Instrument Corp	5508
PAWS Workholding	5866
Phillips Precision Inc	3342
Precision Jig Fixture & Metrology	5831
R&R Fixtures LLC	3318
Roemheld	5661
Strong Hand Tools	5627
TE-CO	5463
Vektec LLC	5026
Vlier Products	5526

Joining Materials

Advance Welding	5870
Aimtek Inc	2108
Ambrell Induction Heating Solutions	2008
Branson Ultrasonics Corp	3235
Cambridge Vacuum Engineering	5857
Lynn Welding	2027
Taylor-Winfield Technologies Inc	2107

Lapping

A. TEC Diamond Co Ltd	5006
Engis Corp	5028
Mirka / Cafro	1711
Nagel Precision Inc	5850
Okamoto Corp	1044
Rock Ridge Abrasives	5743

stratus technologies	5743
Sunnen Products Co	2111
TCI Precision Metals	5030

Lasers & Related Equipment

ACSYS Lasertechnik US Inc	1028
Airgas	1656
Alpha Laser - US	2105
Amada Miyachi America	2101
ARCH Cutting Tools & Beamer Laser Marking Systems	5666
Blum-Novotest, Inc.	5432
Boston Laser Tech	5722
Branson Ultrasonics Corp	3235
Caron Engineering Inc	5432
CGTech	5350
Dapra Marking Systems	2037
ECM Global Measurement Solutions	3008
Electronic Service Products	1620
EMAG LLC	1045
Epilog Laser Corp	2129
Fluid Chillers	1001
FOBA Laser Marking + Engraving Alltec GmbH	3341
Gesswein Co	5653
GF Machining Solutions	1420, 1620
Jinan Bodor CNC Machine Co Ltd	1146
Laser Marking Technologies LLC	2029
LaserStar Technologies Corp	2100
Marposs Corp	1644
Marubeni Citizen Cincom	1406
MB Metal Technologies LLC	2009
Monode	5682
Numberall Stamp & Tool Co	1142
Origin Technologies Corp	1854
Pinpoint Laser Systems	3054
Pratt & Whitney Measurement Systems Inc	3006
Praxair Distribution Inc.	1606
Precision Laser Technology LLC	3154
Preco Inc	5237
Purex Inc	2102
Rollomatic Inc	1706
SIC Marking USA Inc	323
SISMA USA Inc	2104
Starrett Company	3011, 5045
Telesis Technologies Inc	2005
THINBIT	5348
TRUMPF Inc	2004
TYKMA ElectroX	3035
Vytek Laser Systems	2022

Lathe Tooling & Accessories

Air Turbine Tools	5753
ARCH Cutting Tools & Beamer Laser Marking Systems	5666
BENZ Incorporated	5544
Big Kaiser Precision Tooling Inc	5248
Carmex Precision Tools LLC	5016
Centaur Precision Tools Inc	5512
Chumpower Machinery Corp	5770
Cutler Industrial Sales	5469
Flexbar Machine Corp	3157
Genevieve Swiss Industries Inc	5133
Hassay Savage Co	5774
heimatec GmbH	5146
Huot Manufacturing	5469
Internal Tool	5853
iSwiss Corporation	5616
Kitagawa-NorthTech Inc.	1152
Koma Precision Inc	5359

Kyocera Precision Tools Inc	5573
Marposs Corp	1644
Mitsubishi Materials USA	5468
Modern Industries Inc	5750
NTK Cutting Tools	5564
OC White CO	3051
OG Bell Co	5767
Platinum Tooling	5146
Racer Machinery International Inc	1638
REGO-FIX Tool Corp	5320
Rice Machinery Inc	1734
Sauter North America Inc	5423
Schunk Inc	5433
Scientific Cutting Tools Inc	5224
SIMTEK USA Inc.	5636
Somma Tool Co	5542
Southwick & Meister Inc	5387
Star CNC Machine Tool Corp / Eurotech Elite	1444
The Robert E. Morris Company	5464
Tool-Flo Manufacturing Inc	5519
US Shop Tools	5609
Waldmann Lighting Co	1614
Walker Magnetics	5543
Wickman Machine Tool Inc	1822
WTO USA	5223

Lathes Automatic

Acer Group	1705
Alpha Grainger Manufacturing	5683
Brooks Assoc Inc	1206
EMAG LLC	1045
Marubeni Citizen Cincom	1406
Northfield Precision Instrument Corp	5508
Racer Machinery International Inc	1638
Standard Modern Lathes	1638
Star CNC Machine Tool Corp / Eurotech Elite	1444
Syntec Technology Inc	5130
Victor Lathes	1620
Yamazen Inc	1005
Yuasa International	1748

Lathes CNC

ABTech Inc	3012
Acer Group	1705
Air Turbine Tools	5753
Alpha Grainger Manufacturing	5683
American Systems & Equipment Corp	1022
Atrump Machinery Inc	1762
Babin Machine Tool	1743
Brooks Assoc Inc	1206
CGTech	5350
CNC Systems Inc	1328
Cubic Machinery Inc	1021
Dynamic International	1454
EMAG LLC	1045
Fives Giddings & Lewis	1620
Haas Factory Outlet - Trident	1218
Hannsa Precision	1027
Hardinge Inc	5444
Hawkeye Innovation LLC	5838
Huron Machine Products	5000
JH Robotics Inc	1462
KAAST Machine Tools Inc	2134
Kitagawa-NorthTech Inc.	1152
Marubeni Citizen Cincom	1406
MIDACO Corp	1858
Millinocket Fabrication & Machine LLC	2126
Mitsubishi EDM / MC Machinery Systems Inc	1426

Northfield Precision Instrument Corp	5508
Northland Tool & Electronics	5828
NSK America Corp	5344
Perry Technology Corp	5623
Proto Labs Inc	5752
Racer Machinery International Inc	1638
Rice Machinery Inc	1734
Ross Machinery Sales Inc	1620
Sauter North America Inc	5423
Sir Meccanica SpA	5445
Standard Modern Lathes	1638
Star CNC Machine Tool Corp / Eurotech Elite	1444
Syil America Inc	1808
Syntec Technology Inc	5130
The Robert E. Morris Company	5464
Toyoda Americas Corporation	1034
Trak Machine Tools	1434
Victor Lathes	1620
WTO USA	5223
Yamazen Inc	1005
Yuasa International	1748

Lathes Non-Automatic

Acer Group	1705
Babin Machine Tool	1743
Brooks Assoc Inc	1206
Emag Llc	1045
Racer Machinery International Inc	1638
Standard Modern Lathes	1638
Syntec Technology Inc	5130
Victor Lathes	1620

Lean Manufacturing Fundamentals

GH Induction Atmospheres LLC	2033
Hawkeye Innovation LLC	5838
item Northeast	1861
JH Robotics Inc	1462
Laser Marking Technologies LLC	2029
LillyWorks Scheduling & ERP Software	5763
Macdac Engineering	5233
Nexas America LLC	5527
Osaap America	1132
Precision Punch Corp	5633
Pro Ultrasonics	3055
REGO-FIX Tool Corp	5320
Scytec Consulting Inc.	5527
TRUMPF Inc	2004
Turpin Sales & Marketing Inc	5570
VKS - Visual Knowledge Share	5370
Yamazen Inc	1005

Linear Motion Products

Alpine Bearing Co	5669
Axis New England	3328
Chambrelian SAS	2130
CPU Automation Inc	3145
Fagor Automation Corp	2123
Heidenhain Corp	1634
Hiwin Corporation	3034
IAI	3301
Infranor	3145
LaserStar Technologies Corp	2100
Minuteman / Empire Automation Systems	3301
Paletti USA	3239
Parker	5858
Parker Hannifin	3328

Pearse-Bertram LLC	3245
Pinpoint Laser Systems	3054
Preco Inc	5237
Renishaw Inc	3151
Schunk Inc	5433
Siemens Industry Inc	2012
The Hope Group	5858
Vention	329

Lubrication Equipment

Action Bearing Co	5514
Airline Hydraulics Corp	1820
ATAGO USA Inc	5745
Automatic Lube Systems Inc	5869
Blaser-Swisslube	1118
Carbide Related Technologies, Inc.	5765
Chemetall US Inc	3234
Dennison Lubricants	5662
DropsA Lubrication Systems	5869
Faxon Engineering	1768
GTI Spindle Technology Inc	5562
Hangsterfer's Laboratories Inc	5632
HPM Technologie GmbH	5765
Lubrication Technologies Inc	5737
Shell Lubricants	5662
SpiderCool	1241
Takachiho America Inc.	5741
Unist	5523

Machine Accessories

Acer Group	1705
AMF	5146
Atrump Machinery Inc	1762
BUWW Coverings Inc	3335
Caron Engineering Inc	5432
CNC Systems Inc	1328
Control Gaging Inc	3224
Digipas Technologies Inc	5340
Digipas Technologies Inc	5340
Dorner Mfg	5523
Ebbco Inc	1727
Edac Technologies	5553
Fixtureworks	5766
G II Solutions Inc	1253
Gebr. Saacke GmbH & Co. KG	1156
General Manufacturing Inc	1863
GKS Lifting and Moving Solutions LLC	3325
H & R	5469
Haas Factory Outlet - Trident	1218
Hangsterfer's Laboratories Inc	5632
Hardinge Inc	5444
heimatec GmbH	5146
Henninger	5146
Hermann Schmidt Co	1723
Huot Manufacturing	5469
INIRAM Precision Machine Tool Inc	1468
Ketcham & Co Inc	3306
Mach 1 Systems Inc	1725
Marposs Corp	1644
Methods Machine Tools Inc	2034
Midaco Corp	1858
MP Systems	5368
NSK America Corp	5344
Numberall Stamp & Tool Co	1142
OC White CO	3051
OG Bell Co	5767
OMAX Corp	1106
Platinum Tooling	5146
Rapid Air	5523
REGO-FIX Tool Corp	5320
Renishaw Inc	3151

Ross Machinery Sales Inc	1620
Royal Products	5469
Saacke North America LLC	1156
Samchully Workholding	5469
Sauter North America Inc	5423
SMW Autoblok Corp	2013
Somma Tool Co	5542
SpiderCool	1241
Star CNC Machine Tool Corp / Eurotech Elite	1444
Takachiho America Inc.	5741
Tecnicrafts	5146
TE-CO	5463
The Robert E. Morris Company	5464
Tru Tech Systems Inc	1830
Turpin Sales & Marketing Inc	5570
Waldmann Lighting Co	1614
WTO USA	5223
Zimmermann Inc	2137

Machine Castings & Weldments

Automation Engineering Co	5759
Inter-Lakes Bases, Inc.	5759
Laroche Foundry Ltd	5362

Machine Controls

Airline Hydraulics Corp	1820
Axis New England	3328
Babin Machine Tool	1743
Conley Casting Supply Corp	5739
CPU Automation Inc	3145
Electronic Service Products	1620
Elm Electrical	1852
Fagor Automation Corp	2123
Heidenhain Corp	1634
Mitsubishi Electric Automation Inc	1140
Omron	3328
Parker Hannifin	3328
Pearse-Bertram LLC	3245
Quality Vision International	3003
Rice Machinery Inc	1734
Rollomatic Inc	1706
Sanyo Denki	3145
Siemens Industry Inc	2012
Stamptech Inc	5523
The Hope Group	5858
Two Technologies Inc	3326
Unitronics	3145
Vention	329

Machine Tools

Aloris Tool Technology Co Inc	5332
Alpha Grainger Manufacturing	5683
ANCA Inc	1244
Atrump Machinery Inc	1762
Babin Machine Tool	1743
Big Kaiser Precision Tooling Inc	5248
Breton Machine Tools	1620
Brooks Assoc Inc	1206
Buffoli North America	2041
Burr King Manufacturing Co	1713
Chumpower Machinery Corp	5770
Clamptek USA Inc	5684
CNC Systems Inc	1328
Cutler Industrial Sales	5469
Darex LLC	5676
Datron Dynamics Inc	5240

DCM Tech Inc	1125
Dynamic International	1454
Edac Technologies	5553
Emag Llc	1045
Engis Corp	5028
Fluid Chillers	1001
GF Machining Solutions	1420
Haas Factory Outlet - Trident	1218
Hardinge Inc	5444
Hermann Schmidt Co	1723
Huron Machine Products	5000
INIRAM Precision Machine Tool Inc	1468
JM Performance Products Inc	5422
Laser Measuring Technologies LLC	3122
Mach 1 Systems Inc	1725
Makino Inc	1236
Marubeni Citizen Cincom	1406
MCRL Inc / Fluid Chillers	1001
Methods Machine Tools Inc	2034
Midaco Corp	1858
Mikro Industrial Finishing Co	5440
Modern Tools Inc	1127
Multicam East	1035
Northland Tool & Electronics	5828
OC White CO	3051
OG Bell Co	5767
Pocket NC Company	5008
Racer Machinery International Inc	1638
Rapid Air	5523
REGO-FIX Tool Corp	5320
Rice Machinery Inc	1734
Rollomatic Inc	1706
Saacke North America LLC	1156
Sauter North America Inc	5423
Sir Meccanica SpA	5445
Southwick & Meister Inc	5387
SpiderCool	1241
Standard Modern Lathes	1638
Star CNC Machine Tool Corp / Eurotech Elite	1444
Sunnen Products Co	2111
Syntec Technology Inc	5130
Tapeswitch Corporation	336
The Robert E. Morris Company	5464
Turpin Sales & Marketing Inc	5570
Vollmer Of America	1158
Walker Magnetics	5543
Yamazen Inc	1005

Machine Vision Systems

Axis New England	3328
Capture 3D Inc	3044
CPU Automation Inc	3145
Elm Electrical	1852
Fowler High Precision Inc	3251
Gibson Engineering Co Inc	3045
Holts Precision Inc	3156, 5419
J & L Metrology Inc	3255
Judge Tool & Gage	3138
Laser Measuring Technologies LLC	3122
Minuteman / Empire Automation Systems	3301
Mitutoyo America Corp	3111
North Coast Technical	1865
Nysus Solutions LLC	3259
OC White CO	3051
Omron	3328
Pratt & Whitney Measurement Systems Inc	3006
Preco Inc	5237
Quality Vision International	3003
R&R Fixtures LLC	3318
Rush Machinery	1129
Teledyne Dalsa	3145

Werth Inc	3213
Winslow Engineering Inc	2109
Zoller Inc	5436

Machining Centers

Acer Group	1705
ACSYS Lasertechnik US Inc	1028
Alpha Grainger Manufacturing	5683
American Systems & Equipment Corp	1022
Atrump Machinery Inc	1762
Babin Machine Tool	1743
Breton Machine Tools	1620
Brooks Assoc Inc	1206
Buffoli North America	2041
CGTech	5350
CNC Systems Inc	1328
Cubic Machinery Inc	1021
Datron Dynamics Inc	5240
Dynamic International	1454
Edac Technologies	5553
EDM Network Inc	1648
EMAG LLC	1045
Fives Giddings & Lewis	1620
FlexArm Inc	5541
FlexCNC	1228
Gentiger Machinery Industrial Co. Ltd	1061
GF Machining Solutions	1420, 1620
Haas Factory Outlet - Trident	1218
Hannsa Precision	1027
Hardinge Inc	5444
Hawkeye Innovation LLC	5838
INIRAM Precision Machine Tool Inc	1468
KAAST Machine Tools Inc	2134
Kitagawa-NorthTech Inc.	1152
LaserStar Technologies Corp	2100
Makino Inc	1236
Mandelli 5 Axis Machining Centers	1662
Methods Machine Tools Inc	2034
MIDACO Corp	1858
Mikron Corp Monroe	5426
Mitsubishi EDM / MC Machinery Systems Inc	1426
Mitsui Seiki USA	1620
Northeast Machinery Sales/FlexCNC	1228
Northfield Precision Instrument Corp	5508
Northland Tool & Electronics	5828
OC White CO	3051
Ohtori 5 Axis Machining Centers	1662
Perry Technology Corp	5623
Racer Machinery International Inc	1638
Rice Machinery Inc	1734
Ross Machinery Sales Inc	1620
SpiderCool	1241
SW North America Inc	1726
Syil America Inc	1808
Syntec Technology Inc	5130
Takachiho America Inc.	5741
The Robert E. Morris Company	5464
Toshiba Boring Mills	1662
Toyoda Americas Corporation	1034
Trak Machine Tools	1434
Vance Metal Fabricators Inc	1824
Yamazen Inc	1005
Zimmermann Inc	2137

Machining Centers Horizontal Spindle

Alpha Grainger Manufacturing	5683
American Systems & Equipment Corp	1022
Atrump Machinery Inc	1762

Brooks Assoc Inc	1206
Buffoli North America	2041
CNC Systems Inc	1328
Cubic Machinery Inc	1021
Dynamic International	1454
Fives Giddings & Lewis	1620
Haas Factory Outlet - Trident	1218
Hannsa Precision	1027
Makino Inc	1236
Mandelli 5 Axis Machining Centers	1662
Methods Machine Tools Inc	2034
MIDACO Corp	1858
Mikron Corp Monroe	5426
Mitsui Seiki USA	1620
Modern Tools Inc	1127
Northfield Precision Instrument Corp	5508
Northland Tool & Electronics	5828
Racer Machinery International Inc	1638
Rice Machinery Inc	1734
Ross Machinery Sales Inc	1620
SpiderCool	1241
SW North America Inc	1726
Syntec Technology Inc	5130
The Robert E. Morris Company	5464
Toshiba Boring Mills	1662
Toyoda Americas Corporation	1034
Yamazen Inc	1005
Zimmermann Inc	2137

Machining Centers Universal

Brooks Assoc Inc	1206
Buffoli North America	2041
Edac Technologies	5553
GF Machining Solutions	1620
Haas Factory Outlet - Trident	1218
INIRAM Precision Machine Tool Inc	1468
Kgk International Corp	1662
Mandelli 5 Axis Machining Centers	1662
Methods Machine Tools Inc	2034
MIDACO Corp	1858
Northfield Precision Instrument Corp	5508
Northland Tool & Electronics	5828
Racer Machinery International Inc	1638
Rice Machinery Inc	1734
Ross Machinery Sales Inc	1620
SpiderCool	1241
The Robert E. Morris Company	5464
Toshiba Boring Mills	1662
Toyoda Americas Corporation	1034

Machining Centers Vertical Spindle

Acer Group	1705
Atrump Machinery Inc	1762
Babin Machine Tool	1743
Breton Machine Tools	1620
Brooks Assoc Inc	1206
Buffoli North America	2041
CNC Systems Inc	1328
Cubic Machinery Inc	1021
Datron Dynamics Inc	5240
Dynamic International	1454
EMAG LLC	1045
Fives Giddings & Lewis	1620
FlexCNC	1228
GF Machining Solutions	1420, 1620
Haas Factory Outlet - Trident	1218
Hannsa Precision	1027
Hardinge Inc	5444
Hawkeye Innovation LLC	5838

INIRAM Precision Machine Tool Inc	1468
Mach 1 Systems Inc	1725
Makino Inc	1236
Methods Machine Tools Inc	2034
MIDACO Corp	1858
Mitsubishi EDM / MC Machinery Systems Inc	1426
Mitsui Seiki USA	1620
Northfield Precision Instrument Corp	5508
Northland Tool & Electronics	5828
NSK America Corp	5344
Ohtori 5 Axis Machining Centers	1662
Racer Machinery International Inc	1638
Rice Machinery Inc	1734
Ross Machinery Sales Inc	1620
SpiderCool	1241
Standard Modern Lathes	1638
Syil America Inc	1808
Syntec Technology Inc	5130
The Robert E. Morris Company	5464
Toyoda Americas Corporation	1034
Zimmermann Inc	2137

Machinists Aids

Darex LLC	5676
GKS Lifting and Moving Solutions LLC	3325
Gradient Lens Corporation	3150
Hermann Schmidt Co	1723
Mach 1 Systems Inc	1725
Plastics International	5366
Pro Ultrasonics	3055
SpiderCool	1241
The Custom Group Center For Manufacturing Technology	5582

Magnetic Equipment & Tools

Hermann Schmidt Co	1723
Hiwin Corporation	3034
Mitee-Bite Products LLC	5459
Platinum Tooling	5146
Roemheld	5661
Schunk Inc	5433
Strong Hand Tools	5627
Walker Magnetics	5543

Management Services

US Tool Group Inc	5626
-------------------	------

Manufacturing Scheduling & Control

Dassault Systemes	5233
ECi Software Solutions	5532
Elm Electrical	1852
LillyWorks Scheduling & ERP Software	5763
MachineMetrics	5037
Nysus Solutions LLC	3259
ProShop ERP	5847

Manufacturing Services

Advance Welding	5870
Aerospace Alloys Inc	5729
Airline Hydraulics Corp	1820
Conley Casting Supply Corp	5739
Da/Pro Rubber Inc	340

Dorsey Metrology International Inc	3119
Elm Electrical	1852
Front Panel Express	5568
Hardline Heat Treating Inc	2011
Hassay Savage Co	5774
Hawkeye Innovation LLC	5838
Huron Machine Products	5000
Hygrade Precision Technologies	5566
item Northeast	1861
J & L Metrology Inc	3255
JH Robotics Inc	1462
Kalow Technologies	5821
LS Industries Inc	3043
Lynn Welding	2027
MCRL Inc / Fluid Chillers	1001
Penn Stainless Products Inc	5043
Perry Technology Corp	5623
Plastics International	5366
Ram Precision Tool Inc	1626
Rittal Corp	5035
Saturn Industries Inc	1237
Smith & Wesson Precision Components	5365
TCI Precision Metals	5030
The Hope Group	5858
The Joseph Freedman Co Inc	1772
US Tool Group Inc	5626
Vention	329
Vision Engineering Inc	3322

Marking Equipment

Amada Miyachi America	2101
AMF	5146
ARCH Cutting Tools & Beamer Laser Marking Systems	5666
Cutler Industrial Sales	5469
Dapra Marking Systems	2037
Ensitech Inc	5758
FOBA Laser Marking + Engraving I Alltec GmbH	3341
Gibson Engineering Co Inc	3045
Laser Marking Technologies LLC	2029
LaserStar Technologies Corp	2100
Machitech Automation	1656
Marksman represented by Millennium Signatures Marking Systems Inc	3305
MB Metal Technologies LLC	2009
Minuteman / Empire Automation Systems	3301
Monode	5682
Numberall Stamp & Tool Co	1142
Pauway Corp	5549
Phillips Precision Inc	3342
Platinum Tooling	5146
Precision Laser Technology LLC	3154
SIC Marking USA Inc	323
SISMA USA Inc	2104
Technifor	3301
Telesis Technologies Inc	2005
TRUMPF Inc	2004
TYKMA Electrox	3035

Material Handling Equipment & Systems

Acorn Industrial Products Co	5415
Ajax Tocco Magnethermic Corp	1026
Amada Machine Tools America	1754
Behringer Saws Inc	2000
Decade Products Inc	3317
Deluxe Systems	3340
Dorner Mfg	5523
DuBois Chemicals Inc	5449

Ecoclean Inc	3019
Elm Electrical	1852
Ergotron Inc	5144
Fixtureworks	5766
FlexArm Inc	5541
GKS Lifting and Moving Solutions LLC	3325
Hyd-Mech Group Ltd	2122
item Northeast	1861
JH Robotics Inc	1462
Kasto Inc	1661
Modula Inc	1254
NITCO Industrial Cleaning Equipment & Commercial Products	3002
Rapid Air	5523
Schunk Inc	5433
Stor-Loc Corp	5712
Tapeswitch Corporation	336
Taylor-Winfield Technologies Inc	2107
TE-CO	5463
The Joseph Freedman Co Inc	1772
Vention	329
W T Hight CO	3338
Walker Magnetics	5543
Yuasa International	1748

Materials

Aerospace Alloys Inc	5729
Aimtek Inc	2108
Curbell Plastics Inc	5771
GKS Lifting and Moving Solutions LLC	3325
HASCO America Inc.	5010
Matterhackers	5848
Plastics International	5366
Poco Graphite	1227
SciAps Inc	3125
Service Steel Aerospace Corp	5744
TCI Precision Metals	5030
The Joseph Freedman Co Inc	1772
Ultimaker	5732
Vela Instruments LLC	5842
Wickman Machine Tool Inc	1822
Zimmermann Inc	2137

Measuring Tools & Equipment

ABTech Inc	3012
Accurex Measurement Inc	3139
Autodesk Inc	5326
Butler Bros	5637
Caron Engineering Inc	5432
Control Gaging Inc	3224
Digipas Technologies Inc	5340
Digipas Technologies Inc	5340
Dino-Lite Scopes (BigC)	3143
Dorsey Metrology International Inc	3119
ECM Global Measurement Solutions	3008
Fagor Automation Corp	2123
Fastenal Company	5575
Fischer Technology Inc	5738
Fixtureworks	5766
Fowler High Precision Inc	3251
Haimer USA	5458
Heidenhain Corp	1634
Hermann Schmidt Co	1723
Holts Precision Inc	3156, 5419
J & L Metrology Inc	3255
Johnson Gage Co	3042
Judge Tool & Gage	3138
Laser Measuring Technologies LLC	3122
Marposs Corp	1644
Metronor Inc	3127
Mitutoyo America Corp	3111

New Scale Robotics	2139
Nikon Metrology Inc	3203
OC White CO	3051
Omega TMM Inc.	5127
Origin Technologies Corp	1854
Paletti USA	3239
Phillips Precision Inc	3342
Pinpoint Laser Systems	3054
Pratt & Whitney	
Measurement Systems Inc	3006
Precision Jig Fixture & Metrology	5831
Quality Plus Inc	3241
Quality Vision International	3003
R&R Fixtures LLC	3318
Renishaw Inc	3151
Rollomatic Inc	1706
Starrett Company	3011, 5045
Thermo Fisher Scientific	339
Verisurf	5036
Verisurf Software Inc	5050
Vision Engineering Inc	3322
Werth Inc	3213
ZEISS Industrial Metrology	3159
Zoller Inc	5436

Metal Finishing

Advanced Coating Service	5624
Aerodynamics Inc	5482
Anoplate Corp	5726
Armology of Connecticut Inc	5246
Brush Research Manufacturing Co	5608
Chemetal US Inc	3234
DuBois Chemicals Inc	5449
Engis Corp	5028
FARO Technologies Inc	3135
JMD Industries Inc	5536
Laroche Foundry Ltd	5362
LS Industries Inc	3043
Lucifer Furnaces Inc	2003
Mikro Industrial Finishing Co	5440
New England Metal Finishing & Precision Finishing Services	5136
Northeast Coating Technologies	5540
Northeast Machinery Sales/FlexCNC	1228
Pauway Corp	5549
Precision Laser Technology LLC	3154
Rock Ridge Abrasives	5743
Smith & Wesson Precision Components	5365
stratus technologies	5743
Vance Metal Fabricators Inc	1824

Metalfforming & Fabricating Equipment

Airgas	1656
Alpha Laser - US	2105
Amada Marvel Inc	2114
Carlson Fabrication Solutions	2128
CLOMEA / 3C	5820
Ercolina - CML USA Inc	1753
FARO Technologies Inc	3135
FlexArm Inc	5541
Flow International Corp	1712
J&S Machine Inc	5820
KAASST Machine Tools Inc	2134
LaserStar Technologies Corp	2100
Lucifer Furnaces Inc	2003
OMAX Corp	1106
Praxair Distribution Inc.	1606
Radyne Corp	1102
Roemheld	5661

Sanken Industry Co. Ltd.	5749
Seyi America	5523
SIMASV	5820
Stamptech Inc	5523
Suhner Industrial Products Inc	5020
Tapeswitch Corporation	336
TRUMPF Inc	2004
Unist	5523
Vance Metal Fabricators Inc	1824
YLM	5820

Metallurgical Equipment & Services

Bonal Technologies Inc	1136
Diacut Inc	3226
Lucifer Furnaces Inc	2003
Modern Industries Inc	5750
New England Miniature Ball	5364
VJ Technologies Inc	5835

Metallurgy

Hardline Heat Treating Inc	2011
Laroche Foundry Ltd	5362
Lucifer Furnaces Inc	2003
New England Miniature Ball	5364
Rolled Alloys	5232

Metals

Admiral Metals	5516
Aerospace Alloys Inc	5729
Aimtek Inc	2108
Aloris Tool Technology Co Inc	5332
Cambridge Vacuum Engineering	5857
Chapin & Bangs Steel Co/ Lindquist Steels Inc	5012
Conley Casting Supply Corp	5739
Datron Dynamics Inc	5240
Hardline Heat Treating Inc	2011
HASCO America Inc.	5010
Laroche Foundry Ltd	5362
Lucifer Furnaces Inc	2003
NESSteel Inc	5033
New England Miniature Ball	5364
Noble Industrial Furnace	3354
Paletti USA	3239
Penn Stainless Products Inc	5043
Peterson Steel Corp	5558
Proto Labs Inc	5752
ReCarb LLC	5642
Rigaku Analytical Devices	3319
Rolled Alloys	5232
SciAps Inc	3125
Service Steel Aerospace Corp	5744
Supra Alloys A Div of TITAN Metal Fabricators Inc	5643
TCI Precision Metals	5030
The Joseph Freedman Co Inc	1772
United Performance Metals	5728
Vela Instruments LLC	5842
Yarde Metals Inc	2039
Zimmermann Inc	2137

Metric Equipment & Tools

Dorsey Metrology International Inc	3119
Fowler High Precision Inc	3251
HASCO America Inc.	5010

Holts Precision Inc	3156, 5419
J & L Metrology Inc	3255
Johnson Gage Co	3042
Judge Tool & Gage	3138
Laser Measuring Technologies LLC	3122
Mitutoyo America Corp	3111
New Scale Robotics	2139
Paletti USA	3239
Quality Plus Inc	3241
Thermo Fisher Scientific	339

Micro Manufacturing

Air Turbine Tools	5753
Amada Miyachi America	2101
GF Machining Solutions	1420, 1620
Heidenhain Corp	1634
LaserStar Technologies Corp	2100
Makino Inc	1236
Marubeni Citizen Cincom	1406
NSK America Corp	5344
OMAX Corp	1106
Precision Laser Technology LLC	3154
Precision Punch Corp	5633
Ram Precision Tool Inc	1626
REGO-FIX Tool Corp	5320
Sanken Industry Co. Ltd.	5749
Saturn Industries Inc	1237
Tru Tech Systems Inc	1830
Vision Engineering Inc	3322
Yamazen Inc	1005

Milling Cutters End Mills

ANCA Inc	1244
ARCH Cutting Tools & Beamer Laser Marking Systems	5666
Big Kaiser Precision Tooling Inc	5248
Butler Bros	5637
Carbide Grinding Co Inc	5341
Carbide Related Technologies, Inc.	5765
Carmex Precision Tools LLC	5016
Ceratizit	1118
Contour360	5559
Controx Inc	5571
Cutler Industrial Sales	5469
Datron Dynamics Inc	5240
EM Benson Co	5141
Emuge Corp	5369
Fastenal Company	5575
Fullerton Tool Co	5736
Greenleaf Corp	5317
Guhring Inc	5333
GWS Tool Group	5621
GWS/Benchmark Carbide	1118
Hassay Savage Co	5774
HORN USA Inc	5353
Internal Tool	5853
Kyocera Precision Tools Inc	5573
Lexington Cutter	5469
Lindco Springfield Co	1118
LMT Onsrud Tooling	1035
Lovejoy Tool Co	5242
Mach 1 Systems Inc	1725
MAPAL Inc	5327
Mikron Corp Monroe	5426
Mitsubishi Materials USA	5468
Nexgen Tooling	5747
NTK Cutting Tools	5564
OG Bell Co	5767
OSG USA INC	5652
ReCarb LLC	5642
Sandvik Coromant	1118

SIMTEK USA Inc.	5636
Tool-Flo Manufacturing Inc	5519
Turpin Sales & Marketing Inc	5570
US Tool Group Inc	5626
Vollmer Of America	1158
YG-1	1118
YG-1 Tool Co	5474

Milling Machines -Type

Acer Group	1705
Air Turbine Tools	5753
Alpha Grainger Manufacturing	5683
Amada Machine Tools America	1754
American Systems & Equipment Corp	1022
Atrump Machinery Inc	1762
Babin Machine Tool	1743
Buffoli North America	2041
CNC Systems Inc	1328
Cutler Industrial Sales	5469
Datron Dynamics Inc	5240
Dynamic International	1454
Edac Technologies	5553
EMAG LLC	1045
Fives Giddings & Lewis	1620
FlexCNC	1228
GF Machining Solutions	1420
Haas Factory Outlet - Trident	1218
Hardinge Inc	5444
Hawkeye Innovation LLC	5838
INIRAM Precision Machine Tool Inc	1468
KAASST Machine Tools Inc	2134
Kitagawa-NorthTech Inc.	1152
Mach 1 Systems Inc	1725
Makino Inc	1236
Mandelli 5 Axis Machining Centers	1662
Methods Machine Tools Inc	2034
Mitsubishi EDM / MC Machinery Systems Inc	1426
Northfield Precision Instrument Corp	5508
Northland Tool & Electronics	5828
Ohtori 5 Axis Machining Centers	1662
Penn Stainless Products Inc	5043
Pocket NC Company	5008
Rice Machinery Inc	1734
Sir Meccanica SpA	5445
SpiderCool	1241
SW North America Inc	1726
Syil America Inc	1808
The Robert E. Morris Company	5464
Trak Machine Tools	1434
Yamazen Inc	1005
Zimmermann Inc	2137

Modular Fixturing

Advanced Machine & Engineering	5843
Blue Photon Technology & Workholding Systems LLC	5734
Carr Lane Manufacturing/ Carr Lane Roemheld	5659
Dorner Mfg	5523
Erowa Technology Inc	1628
Fixtureworks	5766
Haimer USA	5458
Halder Inc	5427
Hirschmann Engineering USA Inc	1231
Huron Machine Products	5000
INIRAM Precision Machine Tool Inc	1468
item Northeast	1861
Jergens Inc	5644
Lang Technovation Co	5483
Mitee-Bite Products LLC	5459

Modern Industries Inc	5750
Paletti USA	3239
PAWS Workholding	5866
Phillips Precision Inc	3342
R&R Fixtures LLC	3318
Ram Precision Tool Inc	1626
Roemheld	5661
Samchully Workholding	5469
SMW Autoblok Corp	2013
Strong Hand Tools	5627
TE-CO	5463
TRIAG	5843
Vention	329

Molding

Conley Casting Supply Corp	5739
Da/Pro Rubber Inc	340
Precision Laser Technology LLC	3154
Proto Labs Inc	5752
Sanken Industry Co. Ltd.	5749

Moldmaking

Air Turbine Tools	5753
Amada Machine Tools America	1754
Autodesk Inc	5326
Conley Casting Supply Corp	5739
Curbell Plastics Inc	5771
HASCO America Inc.	5010
Lucifer Furnaces Inc	2003
NSK America Corp	5344
OC White CO	3051
Poco Graphite	1227
Precision Laser Technology LLC	3154
Ram Precision Tool Inc	1626
Sanken Industry Co. Ltd.	5749
Tru Tech Systems Inc	1830
Vlier Products	5526

MRP/MRP II Systems

LillyWorks Scheduling & ERP Software	5763
ProShop ERP	5847
VKS - Visual Knowledge Share	5370

Nano Technology

ABTech Inc	3012
Cambridge Vacuum Engineering	5857
GF Machining Solutions	1620
Heidenhain Corp	1634
Mitutoyo America Corp	3111
NSK America Corp	5344
Preco Inc	5237
REGO-FIX Tool Corp	5320
Ultraflex Power Technologies Corp	1138

Noise Reduction & Control

Aquest Corp	3347
Harvey Industries International Inc	3343
Nordfab Ducting	3025

Numerical Control Equipment

Babin Machine Tool	1743
Electronic Service Products	1620
Fagor Automation Corp	2123
Heidenhain Corp	1634
INIRAM Precision Machine Tool Inc	1468
Mitsubishi Electric Automation Inc	1140
Siemens Industry Inc	2012

Oil Mist Collectors

AER Control Systems LLC	5762
Air Cleaning Specialist	5509
Air Filtration Systems	3059
Airflow Systems Inc	3309
Aquest Corp	3347
Blast & Wash Systems	5509
Custom Service Solutions Inc	3218
Ebbco Inc	1727
Eclipse Magnetics	3022
EM Benson Co	5141
Ketcham & Co Inc	3306
Lindco Springfield Co	1118
Marubeni Citizen Cincom	1406
Mikro Industrial Finishing Co	5440
Modern Tools Inc	1127
Nordfab Ducting	3025
Royal Products	5469

Star CNC Machine Tool Corp / Eurotech Elite	1444
Tru Tech Systems Inc	1830
Wickman Machine Tool Inc	1822
Winslow Engineering Inc	2109
Yuasa International	1748

Optical Equipment

4D Technology Corp	3211
ABTech Inc	3012
Accurex Measurement Inc	3139
Capture 3D Inc	3044
Certified Comparator Products (CCP)	3003
Cimquest Inc	5036
Dino-Lite Scopes (BigC)	3143
Dorsey Metrology International Inc	3119
Euro-Tech Corp	5336
Fagor Automation Corp	2123
Flexbar Machine Corp	3157
Fowler High Precision Inc	3251
Glastonbury Southern Gage Thread & Cylindrical Gages And Masters	3254
Gradient Lens Corporation	3150
Hexagon Manufacturing Intelligence	3103
Holts Precision Inc	3156, 5419
J & L Metrology Inc	3255
Judge Tool & Gage	3138
Keyence Corp of America	2042, 3029
Koma Precision Inc	5359
L.F.O'leary Co.Inc/ Glastonbury Southern Gage	3254
Laser Measuring Technologies LLC	3122
Marposs Corp	1644
Metrologic Group Services	3228
Metronor Inc	3127
Mitutoyo America Corp	3111
Nikon Metrology Inc	3203
North Coast Technical	1865
OASIS Inspection Systems	3050
OC White CO	3051
Olympus America Inc	1766
Optical Gaging Products	3003
Pinpoint Laser Systems	3054

Pratt & Whitney	
Measurement Systems Inc	3006
Precision Jig Fixture & Metrology	5831
Quality Plus Inc	3241
Quality Vision International	3003
RAM	3003
Starrett Company	3011, 5045
Teledyne Dalsa	3145
Thermo Fisher Scientific	339
Vision Engineering Inc	3322
Wenzel America Ltd	3223
Werth Inc	3213
Winslow Engineering Inc	2109
ZEISS Industrial Metrology	3159
Zoller Inc	5436

Packaging Materials & Processes

Branson Ultrasonics Corp	3235
Decade Products Inc	3317
Dorner Mfg	5523
Elm Electrical	1852
Liberty Packaging Co	3227
Numberall Stamp & Tool Co	1142
Tapeswitch Corporation	336

Palletizers

Belmont Equipment & Technologies	1248
Dorner Mfg	5523
Erowa Technology Inc	1628
Hirschmann Engineering USA Inc	1231
INIRAM Precision Machine Tool Inc	1468
Jergens Inc	5644
JH Robotics Inc	1462
Kitagawa-NorthTech Inc.	1152
Mitee-Bite Products LLC	5459
Ram Precision Tool Inc	1626
SMW Autoblok Corp	2013
TRIAG	5843
Vektak LLC	5026

Parts Feeders

Ajax Tocco Magnethermic Corp	1026
Atlas Copco Tools/Palmac	1134
Yuasa International	1748

Parts Identification & Marking Systems

Amada Miyachi America	2101
ARCH Cutting Tools & Beamer Laser Marking Systems	5666
Dapra Marking Systems	2037
Dorner Mfg	5523
FOBA Laser Marking + Engraving I Alltec GmbH	3341
Gibson Engineering Co Inc	3045
JH Robotics Inc	1462
Laser Marking Technologies LLC	2029
LaserStar Technologies Corp	2100
Marksman represented by Millennium Signatures Marking Systems Inc	3305
MB Metal Technologies LLC	2009
Minuteman / Empire Automation Systems	3301
Monode	5682
Numberall Stamp & Tool Co	1142
Pauway Corp	5549

Precision Laser Technology LLC	3154
SIC Marking USA Inc	323
SISMA USA Inc	2104
Telesis Technologies Inc	2005
The Robert E. Morris Company	5464
TRUMPF Inc	2004
TYKMA Electro	3035
Wickman Machine Tool Inc	1822

Plant Layout & Design Services

Houghton International Inc	5560
VJ Technologies Inc	5835

Plant Maintenance Services

Acorn Industrial Products Co	5415
Darex LLC	5676
Elm Electrical	1852
Houghton International Inc	5560
Lubrication Technologies Inc	5737
Modula Inc	1254
Pro Ultrasonics	3055
Sir Meccanica SpA	5445
The Hope Group	5858
VJ Technologies Inc	5835
Wickman Machine Tool Inc	1822

Plasma Cutting & Welding

Advance Welding	5870
Aimtek Inc	2108
Airgas	1656
Carlson Fabrication Solutions	2128
Cincinnati Inc	1844
Fluid Chillers	1001
Fronius USA LLC	1737
Machitech Automation	1656
Miller Electric	1656
Millinocket Fabrication & Machine LLC	2126
Multicam East	1035
Penn Stainless Products Inc	5043
Praxair Distribution Inc.	1606
Vance Metal Fabricators Inc	1824
Yarde Metals Inc	2039

Plastic Products

Curbell Plastics Inc	5771
Decade Products Inc	3317
Optinova Americas Inc.	5772
Plastics International	5366
Sanken Industry Co. Ltd.	5749
Tapeswitch Corporation	336

Plastics Machining

Branson Ultrasonics Corp	3235
CIMCO Americas LLC	5716
Curbell Plastics Inc	5771
HPM Technologie GmbH	5765
Lucifer Furnaces Inc	2003
Multicam East	1035
OMAX Corp	1106
Plastics International	5366
Precision Laser Technology LLC	3154
Proto Labs Inc	5752

Plastics Molding

Autodesk Inc	5326
Da/Pro Rubber Inc	340
Plastics International	5366
Poco Graphite	1227
Pro Ultrasonics	3055
Proto Labs Inc	5752
Sanken Industry Co. Ltd.	5749
Tapeswitch Corporation	336

Plastics Processing

Conley Casting Supply Corp	5739
Optinova Americas Inc.	5772
Pauway Corp	5549
Plastics International	5366
Sanken Industry Co. Ltd.	5749

Polishing & Buffing Equipment

A. TEC Diamond Co Ltd	5006
Brush Research Manufacturing Co	5608
Burr King Manufacturing Co	1713
Carlson Fabrication Solutions	2128
EDM Network Inc	1648
Garboli	5820
Gesswein Co	5653
J&S Machine Inc	5820
Mikro Industrial Finishing Co	5440
Nagel Precision Inc	5850
New England Metal Finishing & Precision Finishing Services	5136
New England Sales Inc	2026
NSK America Corp	5344
Okamoto Corp	1044
Rock Ridge Abrasives	5743

Pollution Control

ACM Technologies	3124
AER Control Systems LLC	5762
Air Filtration Systems	3059
Airflow Systems Inc	3309
Aquest Corp	3347
Custom Service Solutions Inc	3218
DuBois Chemicals Inc	5449
Keller Products Inc	3057
Ketcham & Co Inc	3306
MAYFRAN	5469
Pro Ultrasonics	3055
Royal Products	5469
Unist	5523
Ventilation USA LLC	3018

Portable Power Tools

Acorn Industrial Products Co	5415
Air Turbine Tools	5753
Atlas Copco Tools/Palmac	1134
Dynabrade Inc	5677
General Manufacturing Inc	1863
HEM Inc	2038
Sir Meccanica SpA	5445
TRUMPF Inc	2004

Position Sensing

Heidenhain Corp	1634
Hiwin Corporation	3034
Omron	3328
Parker	5858
Pearse-Bertram LLC	3245
Pinpoint Laser Systems	3054
Renishaw Inc	3151
The Hope Group	5858
Vention	329

Positioning Systems

Axis New England	3328
Blum-Novotest, Inc.	5432
Control Gaging Inc	3224
CPU Automation Inc	3145
Dorner Mfg	5523
Fagor Automation Corp	2123
GKS Lifting and Moving Solutions LLC	3325
Hiwin Corporation	3034
Infranor	3145
Omron	3328
Parker	5858
Parker Hannifin	3328
Pearse-Bertram LLC	3245
Pinpoint Laser Systems	3054
Sanyo Denki	3145
The Hope Group	5858
Two Technologies Inc	3326
Vention	329
Verisurf Software Inc	5050

Power Transmission Equipment

General Manufacturing Inc	1863
GKS Lifting and Moving Solutions LLC	3325

Presses

Carlson Fabrication Solutions	2128
Dake	5469
J&S Machine Inc	5820
KAASST Machine Tools Inc	2134
Numberall Stamp & Tool Co	1142
Praxair Distribution Inc.	1606
Rapid Air	5523
Seyi America	5523
SIMASV	5820
Stamptech Inc	5523
Taylor-Winfield Technologies Inc	2107
Vance Metal Fabricators Inc	1824

Preventive Maintenance

ACM Technologies	3124
Acorn Industrial Products Co	5415
Action Bearing Co	5514
Air Inc	3039
Airline Hydraulics Corp	1820
BUWW Coverings Inc	3335
Custom Service Solutions Inc	3218
Darex LLC	5676
DuBois Chemicals Inc	5449
Elm Electrical	1852
Eureka Chemical Co	3243
GTI Spindle Technology Inc	5562
Lubrication Technologies Inc	5737

MachineMetrics	5037
MCRL Inc / Fluid Chillers	1001
Noble Industrial Furnace	3354
Northeast Machinery Sales/FlexCNC	1228
Pinpoint Laser Systems	3054
Pro Ultrasonics	3055
The Hope Group	5858

Production & Inventory Control

LillyWorks Scheduling & ERP Software	5763
MachineMetrics	5037
Modula Inc	1254
Nysus Solutions LLC	3259
Zoller Inc	5436

Production Monitoring Systems

ATAGO USA Inc	5745
Caron Engineering Inc	5432
CPU Automation Inc	3145
Digipas Technologies Inc	5340
Dynics Inc.	3145
LillyWorks Scheduling & ERP Software	5763
Macdac Engineering	5233
MachineMetrics	5037
Nexas America LLC	5527
Nysus Solutions LLC	3259
Scytec Consulting Inc.	5527
WireFreeCNC	5233
Zoller Inc	5436

Programmable Logic Controllers

Airline Hydraulics Corp	1820
Axis New England	3328
CPU Automation Inc	3145
Fagor Automation Corp	2123
IDEC	5858
Macdac Engineering	5233
Mitsubishi Electric Automation Inc	1140
Omron	3328
Parker Hannifin	3328
Pearse-Bertram LLC	3245
Siemens Industry Inc	2012
The Hope Group	5858
Unitronics	3145
Vention	329

Publications

Advanced Machine & Engineering	5843
American Society of Mechanical Engineers	5751
Boston Tooling and Machining Association	
sponsored by CompuMachine	5245
Cutting Tool Engineering Magazine	3315
Design 2 Part Magazine	5725
Fabricating & Metalworking Magazine	3321
Manufacturing News	5864
Modern Machine Shop	5746
SME	1164
SME Education Foundation	1164
SME Media	1164
Tooling U-SME	1164

Pumps & Pumping Systems

Airline Hydraulics Corp	1820
Aquajet Cutting Technology	1654
BlackHawk / Kennametal	5563
Eclipse Magnetics	3022
iSwiss Corporation	5616
Jet Edge	1770
Jorgensen Conveyors, Inc.	5759
Lubrication Technologies Inc	5737
MCRL Inc / Fluid Chillers	1001
Omni Services	5612
Roemheld	5661
Star CNC Machine Tool Corp / Eurotech Elite	1444
Walrus America Inc	5748

Punch Presses

Precision Punch Corp	5633
Proto Labs Inc	5752
Rapid Air	5523
Seyi America	5523
TRUMPF Inc	2004

Punching Equipment

Dorner Mfg	5523
KAASST Machine Tools Inc	2134
Northeast Machinery Sales/FlexCNC	1228
Rapid Air	5523
Tapeswitch Corporation	336
Vance Metal Fabricators Inc	1824

Quality Evaluation Service

Dorsey Metrology International Inc	3119
GTI Spindle Technology Inc	5562
Holts Precision Inc	3156, 5419
item Northeast	1861
Kyzen Corporation	3027
Metronor Inc	3127
Penn Stainless Products Inc	5043

Rapid & Additive Manufacturing

3D Systems	5241
Alpha Additive Manufacturing Technologies	5615
American Society of Mechanical Engineers	5751
Autodesk Inc	5326
Blue Photon Technology & Workholding Systems LLC	5734
CAD BLU Inc	5840
CGTech	5350
Cimquest Inc	5036
Curbell Plastics Inc	5771
FARO Technologies Inc	3135
Gesswein Co	5653
GF Machining Solutions	1420
Matthackers	5848
R & D Technologies	5776
Siemens Industry Inc	2012
SISMA USA Inc	2104
SLM Solutions NA Inc	5733
Ultimaker	5732
Vention	329

Rebuilding Remanufacturing & Retrofitting

Airline Hydraulics Corp	1820
Babin Machine Tool	1743
Control Gaging Inc	3224
Edac Technologies	5553
Electronic Service Products	1620
EMAG LLC	1045
Fagor Automation Corp	2123
G II Solutions Inc	1253
GTI Spindle Technology Inc	5562
J & L Metrology Inc	3255
Kasto Inc	1661
Mach 1 Systems Inc	1725
Marposs Corp	1644
MCRL Inc / Fluid Chillers	1001
Mikro Industrial Finishing Co	5440
Nagel Precision Inc	5850
Noble Industrial Furnace	3354
Northland Tool & Electronics	5828
Pauway Corp	5549
Pro Ultrasonics	3055
Renishaw Inc	3151
Rice Machinery Inc	1734
Ross Machinery Sales Inc	1620
Sauter North America Inc	5423
Siemens Industry Inc	2012
Stamptech Inc	5523
Syntec Technology Inc	5130
Taylor-Winfield Technologies Inc	2107
Toyoda Americas Corporation	1034
Tru Tech Systems Inc	1830
Wenzel America Ltd	3223
Wickman Machine Tool Inc	1822
Winslow Engineering Inc	2109
WTO USA	5223

Recycling Equipment

ACM Technologies	3124
Aquest Corp	3347
Automation Engineering Co	5759
Brucker Corporation	3026
Crest Ultrasonics Corp	3058
Custom Service Solutions Inc	3218
Decade Products Inc	3317
Ebbco Inc	1727
Eclipse Magnetics	3022
Jorgensen Conveyors, Inc.	5759
Keller Products Inc	3057
Ketcham & Co Inc	3306
Lindco Springfield Co	1118
Mayfran	5469
MCRL Inc / Fluid Chillers	1001
New England Sales Inc	2026
ReCarb LLC	5642
RUF Briquetting Systems	3023, 5759
SciAps Inc	3125
stratus technologies	5743
Takachiho America Inc.	5741
UNTHA Shredding Technologies	5759
Vela Instruments LLC	5842
Weima America Inc	335

Renewable Energy

American Society of Mechanical Engineers	5751
Cambridge Vacuum Engineering	5857
Purex Inc	2102
Sprague Operating Resources LLC	3313

Research & Development Services

American Society of Mechanical Engineers	5751
Dorsey Metrology International Inc	3119
Penn Stainless Products Inc	5043
Plastics International	5366
Saturn Industries Inc	1237

Reverse Engineering

Accurex Measurement Inc	3139
Autodesk Inc	5326
BUWW Coverings Inc	3335
Capture 3D Inc	3044
Cimquest Inc	5036
ECM Global Measurement Solutions	3008
Hexagon Manufacturing Intelligence	3103
J & L Metrology Inc	3255
Kalow Technologies	5821
Macdac Engineering	5233
Mastercam/CNC Software Inc	5249
NCSIMUL Hexagon	
Manufacturing Intelligence	5358
North Coast Technical	1865
Perry Technology Corp	5623
Precision Jig Fixture & Metrology	5831
Swoosh Technologies	5338
Verisurf Software Inc	5050
ZEISS Industrial Metrology	3159

Robots Equipment Tooling & Accessories

ABB	3301
Aimtek Inc	2108
Air Inc	3039
Airgas	1656
Axis New England	3328
Capture 3D Inc	3044
Carlson Fabrication Solutions	2128
CGTech	5350
Cubic Machinery Inc	1021
Dorner Mfg	5523
Elm Electrical	1852
EM Benson Co	5141
Erowa Technology Inc	1628
FANUC America Corp	1018
Force Automation	5509
Gibson Engineering Co Inc	3045
Hiwin Corporation	3034
JH Robotics Inc	1462
Kolver	5619
Koma Precision Inc	5359
MIDACO Corp	1858
Minuteman / Empire Automation Systems	3301
Modula Inc	1254
New Scale Robotics	2139
North Coast Technical	1865
Northeast Machinery Sales/FlexCNC	1228
Nysus Solutions LLC	3259
Omron	3328
Parker Hannifin	3328
Praxair Distribution Inc.	1606
Ram Precision Tool Inc	1626
Schunk Inc	5433
Star CNC Machine Tool Corp / Eurotech Elite	1444
Syntec Technology Inc	5130
Taylor-Winfield Technologies Inc	2107
The Robert E. Morris Company	5464
Two Technologies Inc	3326

Universal Robots	3328
Universal Robots USA Inc	1017
Vention	329
VJ Technologies Inc	5835
Zoller Inc	5436

Roll Forming Mills Rolls

Conley Casting Supply Corp	5739
Millinocket Fabrication & Machine LLC	2126
Praxair Distribution Inc.	1606
Vance Metal Fabricators Inc	1824

Rotary Tables

ABTech Inc	3012
Babin Machine Tool	1743
Belmont Equipment & Technologies	1248
Faxon Engineering	1768
Gibson Engineering Co Inc	3045
Hardinge Inc	5444
Herrmann Schmidt Co	1723
Hirschmann Engineering USA Inc	1231
Hiwin Corporation	3034
Jergens Inc	5644
Kitagawa-NorthTech Inc.	1152
Koma Precision Inc	5359
Lyndex-Nikken Inc	5533
OMAX Corp	1106
Parker Hannifin	3328
Platinum Tooling	5146
R&R Fixtures LLC	3318
Renishaw Inc	3151
Ross Machinery Sales Inc	1620
Samchully Workholding	5469
Sauter North America Inc	5423
Schunk Inc	5433
Strong Hand Tools	5627
Yuasa International	1748

Safety & Protection Equipment

Air Inc	3039
Aquest Corp	3347
Butler Bros	5637
CPU Automation Inc	3145
Custom Service Solutions Inc	3218
Ergo Advantage	5617
General Manufacturing Inc	1863
Gibson Engineering Co Inc	3045
Multicam East	1035
Nordfab Ducting	3025
Pinnacle Systems	1035
Plastics International	5366
Rotarex Inc NA	5583
Royal Products	5469
Stamptech Inc	5523
Swivellink	3145
Wieland	3145

Sandblasting

Advanced Coating Service	5624
Force Automation	5509
Laroche Foundry Ltd	5362
Mikro Industrial Finishing Co	5440
Millinocket Fabrication & Machine LLC	2126
New England Metal Finishing & Precision Finishing Services	5136
Pauway Corp	5549
Rice Machinery Inc	1734

Rock Ridge Abrasives	5743
Smith & Wesson Precision Components	5365
stratus technologies	5743
Vance Metal Fabricators Inc	1824

Sanding Equipment

Blast & Wash Systems	5509
Blast it All	5509
Carlson Fabrication Solutions	2128
Gibson Abrasive Equipment	5509
Rock Ridge Abrasives	5743
stratus technologies	5743
Vapor Honing Technologies	5509

Saw Blades

Advanced Machine & Engineering	5843
Amada Machine Tools America	1754
Amada Marvel Inc	2114
ANCA Inc	1244
Butler Bros	5637
Controx Inc	5571
Cosen Saws	2142
Dake	5469
Diacut Inc	3226
DoALL Sawing Products	2133
Doringer Cold Saws	2035
Engis Corp	5028
Fastenal Company	5575
Fullerton Tool Co	5736
Genevieve Swiss Industries Inc	5133
Lexington Cutter	5469
Lindco Springfield Co	1118
Martindale Electric Co	5719
Maxtool Corp.	5002
OG Bell Co	5767
Starrett Company	3011, 5045

Saw Sharpening

Controx Inc	5571
Fullerton Tool Co	5736
Martindale Electric Co	5719
OG Bell Co	5767

Sawing Machines & Systems

Advanced Machine & Engineering	5843
Amada Machine Tools America	1754
Amada Marvel Inc	2114
Behringer Saws Inc	2000
Cosen Saws	2142
Dake	5469
DoALL Sawing Products	2133
Doringer Cold Saws	2035
HEM Inc	2038
Hyd-Mech Group Ltd	2122
KAASST Machine Tools Inc	2134
Kasto Inc	1661
Laser Measuring Technologies LLC	3122
MetalMizer	1814
Northeast Machinery Sales/FlexCNC	1228
Pat Mooney Inc.	1228
Penn Stainless Products Inc	5043
Racer Machinery International Inc	1638
Ross Machinery Sales Inc	1620
Yuasa International	1748

Screw Machining

Air Filtration Systems	3059
Alpha Grainger Manufacturing	5683
Arnold Supply Inc	5548
Buffoli North America	2041
Butler Bros	5637
Cubic Machinery Inc	1021
Hygrade Precision Technologies	5566
Marubeni Citizen Cincom	1406
REGO-FIX Tool Corp	5320
Saturn Industries Inc	1237
Somma Tool Co	5542
Wickman Machine Tool Inc	1822

Screwdrivers Automatic Electric & Pneumatic

Atlas Copco Tools/Palmac	1134
Kolver	5619

Seals & Sealants

Action Bearing Co	5514
Curbell Plastics Inc	5771
Omni Services	5612
Parker	5858
The Hope Group	5858

Sensors

Axis New England	3328
Baumer	3301
Caron Engineering Inc	5432
Digipas Technologies Inc	5340
Marposh Corp	1644
Minuteman / Empire Automation Systems	3301
Mitutoyo America Corp	3111
Omron	3328
Parker	5858
Pearse-Bertram LLC	3245
Pinpoint Laser Systems	3054
Quality Vision International	3003
Renishaw Inc	3151
The Hope Group	5858
Wieland	3145

Servo Equipment & Repair

Axis New England	3328
Copley Controls	3328
CPU Automation Inc	3145
Fagor Automation Corp	2123
Infranor	3145
Mitsubishi Electric Automation Inc	1140
Omron	3328
Parker Hannifin	3328
Sanyo Denki	3145
Siemens Industry Inc	2012

Shears

Carlson Fabrication Solutions	2128
Cincinnati Inc	1844
KAASST Machine Tools Inc	2134
Praxair Distribution Inc.	1606
Taylor-Winfield Technologies Inc	2107
TRUMPF Inc	2004
Vance Metal Fabricators Inc	1824

Sheet Metal & Plate Fabrication

Advance Welding	5870
Airgas	1656
Carlson Fabrication Solutions	2128
Flow International Corp	1712
Machitech Automation	1656
Miller Electric	1656
Mitsubishi EDM /	
MC Machinery Systems Inc	1426
Northeast Machinery Sales/FlexCNC	1228
OMAX Corp	1106
Penn Stainless Products Inc	5043
Praxair Distribution Inc.	1606
Precision Punch Corp	5633
Preco Inc	5237
Proto Labs Inc	5752
Sanken Industry Co. Ltd.	5749
Seyi America	5523
TRUMPF Inc	2004
Vance Metal Fabricators Inc	1824

Software - ERP/MRP/CIM

Dynics Inc.	3145
LillyWorks Scheduling & ERP Software	5763
Macdac Engineering	5233
MachineMetrics	5037
Nysus Solutions LLC	3259
ProShop ERP	5847
QAD Inc	1869
ShopFloorConnect	5668
VJ Technologies Inc	5835
VKS - Visual Knowledge Share	5370

Software ERP/MRP & Supply Chain Management

Dassault Systemes	5233
ECi Software Solutions	5532
Epicor Software Corp	3240
High QA, Inc	341
LillyWorks Scheduling & ERP Software	5763
Macdac Engineering	5233
MachineMetrics	5037
ProShop ERP	5847
Realtrac ERP	5721
ShopFloorConnect	5668
Shoptech	5552
WireFreeCNC	5233

Software Off-Line Programming

Access Manufacturing Systems	5452
ANCA Inc	1244
CPU Automation Inc	3145
Dassault Systemes	5233
Griffo Brothers Inc	5034
MastercamÆ	5233
MULTICAM EAST	1035
Omron	3328
Quality Vision International	3003

Software Quality Control & Inspection Systems

Accurex Measurement Inc	3139
Blum-Novotest, Inc.	5432
Capture 3D Inc	3044
Caron Engineering Inc	5432
Certified Comparator Products (CCP)	3003
CPU Automation Inc	3145
Dino-Lite Scopes (BigC)	3143
DISCUS Software Company	3238
ECi Software Solutions	5532
ECM Global Measurement Solutions	3008
Euro-Tech Corp	5336
FARO Technologies Inc	3135
Fowler High Precision Inc	3251
Glastonbury Southern Gage Thread & Cylindrical Gages And Masters	3254
GTI Spindle Technology Inc	5562
Helmel Engineering Products Inc	3207
Hexagon Manufacturing Intelligence	3103
High QA, Inc	341
Holts Precision Inc	3156, 5419
InnovMetric Software Inc	3244
ITACA	3003
Johnson Gage Co	3042
Judge Tool & Gage	3138
Keyence Corp of America	3029
Koma Precision Inc	5359
KOTEM	3003
L.F.O'leary Co.Inc/	
Glastonbury Southern Gage	3254
Laser Measuring Technologies LLC	3122
Marposh Corp	1644
Metrologic Group Services	3228
Metronor Inc	3127
Mitutoyo America Corp	3111
Nexas America LLC	5527
Nikon Metrology Inc	3203
Nysus Solutions LLC	3259
OASIS Inspection Systems	3050
Optical Gaging Products	3003
Origin Technologies Corp	1854
Pinpoint Laser Systems	3054
Pratt & Whitney	
Measurement Systems Inc	3006
Quality Plus Inc	3241
Quality Vision International	3003
RAM	3003
ShapeGrabber 3D Scanners	3003
Starrett Company	3011, 5045
Swoosh Technologies	5338
Teledyne Dalsa	3145
Thermo Fisher Scientific	339
Verisurf Software Inc	5050
VKS - Visual Knowledge Share	5370
Wenzel America Ltd	3223
Winslow Engineering Inc	2109
ZEISS Industrial Metrology	3159
Zoller Inc	5436

Software Shop Floor Control Systems

Caron Engineering Inc	5432
CIMCO Americas LLC	5716
CPU Automation Inc	3145
Dassault Systemes	5233
Dynics Inc.	3145
ECi Software Solutions	5532
Epicor Software Corp	3240
LillyWorks Scheduling & ERP Software	5763
Macdac Engineering	5233

A photograph of a man and a woman in a professional setting. The man, on the left, has grey hair and a mustache, and is wearing a light blue button-down shirt. He is leaning forward, pointing with his right index finger at a small, silver, cylindrical mechanical component that is resting on a white rectangular block. The woman, on the right, has dark hair pulled back and is wearing a dark blue button-down shirt. She is looking intently at the component and has her hands positioned as if she is about to touch it or is gesturing while speaking. The background is a blurred office or laboratory environment with large windows.

Advancing Manufacturing.

Then. Now. Tomorrow.

SME has a rich heritage spanning almost 90 years. From the beginning, we've led the charge to advance manufacturing by providing critical technical knowledge, invaluable connections, and tools to attract and train succeeding generations. We were there for you then, we're here for you now and we know what you'll need tomorrow.

Discover how SME can help your organization learn, connect and grow. Visit sme.org.

INSPIRED. EDUCATED. PROSPEROUS

MachineMetrics	5037
Nexas America LLC	5527
Quality Vision International	3003
Realtrac ERP	5721
Scytec Consulting Inc.	5527
ShopFloorConnect	5668
Shoptech	5552
Siemens Industry Inc	2012
Swoosh Technologies	5338
VKS - Visual Knowledge Share	5370
WireFreeCNC	5233
Zoller Inc	5436

Software Simulation

Access Manufacturing Systems	5452
AutoForm Engineering USA Inc	5467
LillyWorks Scheduling & ERP Software	5763
NCSIMUL Hexagon	
Manufacturing Intelligence	5358
Swoosh Technologies	5338

Software Simulation Process Modeling

CGTech	5350
CIMCO Americas LLC	5716
LillyWorks Scheduling & ERP Software	5763
MachineMetrics	5037
NCSIMUL Hexagon	
Manufacturing Intelligence	5358
Zoller Inc	5436

Software SPC/SQC

Capture 3D Inc	3044
Caron Engineering Inc	5432
DISCUS Software Company	3238
Dynics Inc.	3145
ECi Software Solutions	5532
Hexagon Manufacturing Intelligence	3103
High QA, Inc	341
Holts Precision Inc	3156, 5419
Judge Tool & Gage	3138
KOTEM	3003
L.F.O'leary Co.Inc/ Glastonbury Southern Gage	3254
Marposs Corp	1644
Metrologic Group Services	3228
Nysus Solutions LLC	3259
Quality Vision International	3003
Verisurf	5036
Verisurf Software Inc	5050
VKS - Visual Knowledge Share	5370

Sorting & Separating Equipment

Derner Mfg	5523
Elm Electrical	1852
GKS Lifting and Moving Solutions LLC	3325
MAYFRAN	5469
Modula Inc	1254
The Joseph Freedman Co Inc	1772
Vela Instruments LLC	5842

Spindle Machines

Air Turbine Tools	5753
Aloris Tool Technology Co Inc	5332
Buffoli North America	2041
Fluid Chillers	1001
GTI Spindle Technology Inc	5562
Mach 1 Systems Inc	1725
Methods Machine Tools Inc	2034
New England Sales Inc	2026
Northland Tool & Electronics	5828
NSK America Corp	5344
Suhner Industrial Products Inc	5020
SW North America Inc	1726

Spindle Tooling

Air Turbine Tools	5753
Aloris Tool Technology Co Inc	5332
ARCH Cutting Tools & Beamer Laser Marking Systems	5666
Big Kaiser Precision Tooling Inc	5248
Briney Tooling Systems	5736
Centaur Precision Tools Inc	5512
Chumpower Machinery Corp	5770
Emuge Corp	5369
Genevieve Swiss Industries Inc	5133
GF Machining Solutions	1420
GTI Spindle Technology Inc	5562
Haimer	1118
heimatec GmbH	5146
Henninger	5146
iSwiss Corporation	5616
JM Performance Products Inc	5422
LMT Onsrud Tooling	1035
Lovejoy Tool Co	5242
Mach 1 Systems Inc	1725
MAPAL Inc	5327
NSK America Corp	5344
OSG USA INC	5652
Platinum Tooling	5146
REGO-FIX Tool Corp	5320
Sauter North America Inc	5423

Spindles

ABTech Inc	3012
Advanced Machine & Engineering	5843
Air Turbine Tools	5753
Aloris Tool Technology Co Inc	5332
Chumpower Machinery Corp	5770
Datron Dynamics Inc	5240
Edac Technologies	5553
Fluid Chillers	1001
G II Solutions Inc	1253
GF Machining Solutions	1420
GTI Spindle Technology Inc	5562
Mach 1 Systems Inc	1725
Northland Tool & Electronics	5828
NSK America Corp	5344
Siemens Industry Inc	2012
Suhner Industrial Products Inc	5020
Wickman Machine Tool Inc	1822

Springs

HASCO America Inc.	5010
Vlier Products	5526

Stainless Steel Fabrication & Finishing

Acorn Industrial Products Co	5415
Advance Welding	5870
Aerospace Alloys Inc	5729
Automation Engineering Co	5759
Inter-Lakes Bases, Inc.	5759
J & L Metrology Inc	3255
Lynn Welding	2027
Millinocket Fabrication & Machine LLC	2126
Pauway Corp	5549
Penn Stainless Products Inc	5043
Precision Laser Technology LLC	3154
Proto Labs Inc	5752
Rittal Corp	5035
Sanken Industry Co. Ltd.	5749
TCI Precision Metals	5030
United Performance Metals	5728
Yamazen Inc	1005

Stamping

Monode	5682
Northeast Machinery Sales/FlexCNC	1228
Numberall Stamp & Tool Co	1142
Precision Punch Corp	5633
Rapid Air	5523
Seyi America	5523
Stamptech Inc	5523
Tapeswitch Corporation	336
W & H Stampings & Fineblanking	5550

Systems Integrators

Caron Engineering Inc	5432
Conley Casting Supply Corp	5739
Dermer Mfg	5523
ECM Global Measurement Solutions	3008
Elm Electrical	1852
Fagor Automation Corp	2123
G II Solutions Inc	1253
INIRAM Precision Machine Tool Inc	1468
Macdac Engineering	5233
MachineMetrics	5037
MB Metal Technologies LLC	2009
Nexas America LLC	5527
Nysus Solutions LLC	3259
Preco Inc	5237
Rittal Corp	5035
Seeburger Inc	5844
Taylor-Winfield Technologies Inc	2107
The Hope Group	5858

Table Systems

ABTech Inc	3012
Hiwin Corporation	3034
item Northeast	1861
Jergens Inc	5644
Mitee-Bite Products LLC	5459
R&R Fixtures LLC	3318
SMW Autoblok Corp	2013
Stor-Loc Corp	5712
Strong Hand Tools	5627
TRIAG	5843
Workplace Modular Systems LLC	5658
Zimmermann Inc	2137

Tables Indexing Leveling Slide

Automation Engineering Co	5759
Dorner Mfg	5523

Tapping & Threading Machines

Automation Engineering Co	5759
FlexArm Inc	5541
FlexCNC	1228
Haas Factory Outlet - Trident	1218
Hypneumat/Commander/Snow	5759
Methods Machine Tools Inc	2034
Sir Meccanica SpA	5445
Somma Tool Co	5542
Sugino Corp.	5759
Suhner Industrial Products Inc	5020
Syil America Inc	1808
Syntec Technology Inc	5130

Tapping Attachments

Automation Engineering Co	5759
Big Kaiser Precision Tooling Inc	5248
Briney Tooling Systems	5736
Centaur Precision Tools Inc	5512
Chumpower Machinery Corp	5770
Emuge Corp	5369
Genevieve Swiss Industries Inc	5133
Hypneumat/Commander/Snow	5759
iSwiss Corporation	5616
Mitsubishi Materials USA	5468
REGO-FIX Tool Corp	5320
Sugino Corp.	5759

Tapping Mechanisms

Automation Engineering Co	5759
FlexArm Inc	5541
Hypneumat/Commander/Snow	5759
Methods Machine Tools Inc	2034
Somma Tool Co	5542
Sugino Corp.	5759

Taps & Dies

ANCA Inc	1244
Carmex Precision Tools LLC	5016
Emuge Corp	5369
Fastenal Company	5575
Guhring Inc	5333
iSwiss Corporation	5616
Kyocera Precision Tools Inc	5573
Maxtool Corp.	5002
Mikron Corp Monroe	5426
OSG USA INC	5652
ReCarb LLC	5642
Turpin Sales & Marketing Inc	5570
US Tool Group Inc	5626
YG-1 Tool Co	5474

Testing Equipment & Services

Accurex Measurement Inc	3139
ATAGO USA Inc	5745
Bonal Technologies Inc	1136
Digipas Technologies Inc	5340
Digipas Technologies Inc	5340
Dino-Lite Scopes (BigC)	3143

Gradient Lens Corporation

InnovMetric Software Inc	3244
Nysus Solutions LLC	3259
OC White CO	3051
Quality Vision International	3003
Renishaw Inc	3151
VJ Technologies Inc	5835
VKS - Visual Knowledge Share	5370

Thread Mills

Advent Tool & Manufacturing Inc.	5469
Allied Machine & Engineering	5453
ANCA Inc	1244
Carbide Grinding Co Inc	5341
Carbide Related Technologies, Inc.	5765
Carmex Precision Tools LLC	5016
Contour360	5559
Cutler Industrial Sales	5469
EM Benson Co	5141
Emuge Corp	5369
Genevieve Swiss Industries Inc	5133
Guhring Inc	5333
GWS Tool Group	5621
GWS/Benchmark Carbide	1118
HORN USA Inc	5353
Internal Tool	5853
iSwiss Corporation	5616
Kyocera Precision Tools Inc	5573
Lindco Springfield Co	1118
Maxtool Corp.	5002
Melin Tool Company	5618
Mikron Corp Monroe	5426
Mitsubishi Materials USA	5468
OSG USA INC	5652
Scientific Cutting Tools Inc	5224
SIMTEK USA Inc.	5636
Tool-Flo Manufacturing Inc	5519
Turpin Sales & Marketing Inc	5570
US Tool Group Inc	5626
Vollmer Of America	1158
YG-1	1118
YG-1 Tool Co	5474

Threadmaking Tools

Advent Tool & Manufacturing Inc.	5469
Allied Machine & Engineering	5453
ANCA Inc	1244
BENZ Incorporated	5544
Butler Bros	5637
Carmex Precision Tools LLC	5016
Contour360	5559
Datron Dynamics Inc	5240
Emuge Corp	5369
Genevieve Swiss Industries Inc	5133
Guhring Inc	5333
Internal Tool	5853
iSwiss Corporation	5616
Mikron Corp Monroe	5426
Modern Industries Inc	5750
OC White CO	3051
OSG USA INC	5652
Scientific Cutting Tools Inc	5224
SIMTEK USA Inc.	5636
THINBIT	5348
Tool-Flo Manufacturing Inc	5519
Turpin Sales & Marketing Inc	5570
Vollmer Of America	1158

Tool Monitoring Systems

Caron Engineering Inc	5432
Custom Service Solutions Inc	3218
Electronic Service Products	1620
INIRAM Precision Machine Tool Inc	1468
MachineMetrics	5037
Marposh Corp	1644
NCSIMUL Hexagon	
Manufacturing Intelligence	5358
Nexas America LLC	5527
Pinpoint Laser Systems	3054
Zoller Inc	5436

Toolholders

Allied Machine & Engineering	5453
Aloris Tool Technology Co Inc	5332
ARCH Cutting Tools & Beamer Laser Marking Systems	5666
BENZ Incorporated	5544
Big Kaiser Precision Tooling Inc	5248
Briney Tooling Systems	5736
Butler Bros	5637
Carmex Precision Tools LLC	5016
Centaur Precision Tools Inc	5512
Chumpower Machinery Corp	5770
Cutler Industrial Sales	5469
Electrodes Inc	1128
EM Benson Co	5141
Emuge Corp	5369
Fitz-Rite Products Inc	5645
Genevieve Swiss Industries Inc	5133
GF Machining Solutions	1420
Greenleaf Corp	5317
Guhring Inc	5333
Haimer	1118
Haimer USA	5458
Hardinge Inc	5444
heimatec GmbH	5146
HORN USA Inc	5353
Internal Tool	5853
iSwiss Corporation	5616
JM Performance Products Inc	5422
Koma Precision Inc	5359
Kyocera Precision Tools Inc	5573
Lyndex-Nikken Inc	5533
Mach 1 Systems Inc	1725
MAPAL Inc	5327
Maxtool Corp.	5002
Mitsubishi Materials USA	5468
Modern Industries Inc	5750
Multicam East	1035
NTK Cutting Tools	5564
OSG USA INC	5652
Platinum Tooling	5146
REGO-FIX Tool Corp	5320
Rollomatic Inc	1706
Sauter North America Inc	5423
Schunk Inc	5433
Scientific Cutting Tools Inc	5224
SIMTEK USA Inc.	5636
Somma Tool Co	5542
THINBIT	5348
Tool-Flo Manufacturing Inc	5519
Turpin Sales & Marketing Inc	5570
US Shop Tools	5609
WTO USA	5223
YG-1 Tool Co	5474
Zoller Inc	5436

Tooling Roll Forming

Advance Welding 5870

Tooling Tube & Pipe Related

CLOMEA / 3C 5820
 Ercolina - CML USA Inc 1753
 OMAX Corp 1106
 Strong Hand Tools 5627
 YLM 5820

Tooling, Ironworker

Carlson Fabrication Solutions 2128
 Northeast Machinery Sales/FlexCNC 1228
 Praxair Distribution Inc. 1606

Tools Abrasive

Aloris Tool Technology Co Inc 5332
 Brush Research Manufacturing Co 5608
 Chumpower Machinery Corp 5770
 Diacut Inc 3226
 Engis Corp 5028
 Gesswein Co 5653
 Regal Diamond Products 5547
 Sunnen Products Co 2111

Tools Hand Electric & Air

Acorn Industrial Products Co 5415
 Air Turbine Tools 5753
 Atlas Copco Tools/Palmac 1134
 Dino-Lite Scopes (BigC) 3143
 Dynabrade Inc 5677
 Engis Corp 5028
 General Manufacturing Inc 1863
 Gesswein Co 5653
 Halder Inc 5427
 Kolver 5619
NSK America Corp 5344
 Numberall Stamp & Tool Co 1142

Tools Power

Air Turbine Tools 5753
 Airgas 1656
 Atlas Copco Tools/Palmac 1134
 Dynabrade Inc 5677

Tools Reconditioned

Atlas Copco Tools/Palmac 1134
 Dynabrade Inc 5677
 Fastenal Company 5575
GWS Tool Group 5621
 US Tool Group Inc 5626

Transfer Machines

Alpha Grainger Manufacturing 5683
 Edac Technologies 5553
 Mikron Corp Monroe 5426
 Racer Machinery International Inc 1638
 SW North America Inc 1726

Turning Centers

Alpha Grainger Manufacturing 5683
 American Systems & Equipment Corp 1022
 Atrump Machinery Inc 1762
 Breton Machine Tools 1620
 Brooks Assoc Inc 1206
 Buffoli North America 2041
 CNC Systems Inc 1328
 Dynamic International 1454
 Edac Technologies 5553
 EMAG LLC 1045
 Fives Giddings & Lewis 1620
 Haas Factory Outlet - Trident 1218
 Hardinge Inc 5444
 Iniram Precision Machine Tool Inc 1468
 KAAST Machine Tools Inc 2134
 Kitagawa-NorthTech Inc. 1152
Marubeni Citizen Cincom 1406
Methods Machine Tools Inc 2034
 Midaco Corp 1858
 Mitsubishi EDM /
 MC Machinery Systems Inc 1426
 Northland Tool & Electronics 5828
NSK America Corp 5344
 OC White CO 3051
 Perry Technology Corp 5623
 Racer Machinery International Inc 1638
 Ross Machinery Sales Inc 1620
 Standard Modern Lathes 1638
**Star CNC Machine Tool Corp /
 Eurotech Elite 1444**
 Takachiho America Inc. 5741
 The Robert E. Morris Company 5464
 Toshiba Boring Mills 1662
Toyoda Americas Corporation 1034
Trak Machine Tools 1434
 Yuasa International 1748

Turning Tools

Aloris Tool Technology Co Inc 5332
 ARCH Cutting Tools &
 Beamer Laser Marking Systems 5666
 Butler Bros 5637
 Carmex Precision Tools LLC 5016
 Ceratizit 1118
 Everede Tool Company 5649
 Genevieve Swiss Industries Inc 5133
Greenleaf Corp 5317
 Guhring Inc 5333
GWS Tool Group 5621
 heimatec GmbH 5146
HORN USA Inc 5353
 Internal Tool 5853
 iSwiss Corporation 5616
Kyocera Precision Tools Inc 5573
 Mapal Inc 5327
 Maxtool Corp. 5002
 Mikron Corp Monroe 5426
 Mitsubishi Materials USA 5468
 Modern Industries Inc 5750
NTK Cutting Tools 5564
 OG Bell Co 5767
Platinum Tooling 5146
 REGO-FIX Tool Corp 5320
Sandvik Coromant 1118
 Sauter North America Inc 5423
 SIMTEK USA Inc. 5636
Somma Tool Co 5542
 Southwick & Meister Inc 5387
 THINBIT 5348
 Tool-Flo Manufacturing Inc 5519

Ultrasonic Equipment & Systems

Advanced Coating Service 5624
 Blast & Wash Systems 5509
 Branson Ultrasonics Corp 3235
 Cleaning Technologies Group 3219
 Crest Ultrasonics Corp 3058
 Ecoclean Inc 3019
 Gesswein Co 5653
 JRI/JenFab Wash Systems 5509
 Ketcham & Co Inc 3306
 Magido USA 1838
 MCRL Inc / Fluid Chillers 1001
 Mikro Industrial Finishing Co 5440
 New England Metal Finishing
 & Precision Finishing Services 5136
 New England Sales Inc 2026
 Pro Ultrasonics 3055
 REGO-FIX Tool Corp 5320
 Rock Ridge Abrasives 5743
 stratus technologies 5743
 Takachiho America Inc. 5741

Vacuum Systems

AER Control Systems LLC 5762
 Air Inc 3039
 Aquest Corp 3347
 Darex LLC 5676
 Datron Dynamics Inc 5240
 Eclipse Magnetics 3022
 Gibson Engineering Co Inc 3045
 Minuteman / Empire
 Automation Systems 3301
 Mitee-Bite Products LLC 5459
 Purex Inc 2102
 Royal Products 5469
 Schmalz 3301

Vibration Control

Acorn Industrial Products Co 5415
 Air Inc 3039
 AirLoc Corp 5769
 Digipas Technologies Inc 5340
 GTI Spindle Technology Inc 5562
Vlier Products 5526

Vibratory Finishing

Blast & Wash Systems 5509
 Burr King Manufacturing Co 1713
 Chemetall US Inc 3234
 Conley Casting Supply Corp 5739
 DuBois Chemicals Inc 5449
 LS Industries Inc 3043
 Mikro Industrial Finishing Co 5440
 New England Metal Finishing
 & Precision Finishing Services 5136
 New England Sales Inc 2026
 Rock Ridge Abrasives 5743
 Smith & Wesson Precision Components 5365
 stratus technologies 5743

Vises & Vise Jaws

Advanced Machine & Engineering	5843
Alorix Tool Technology Co Inc	5332
Belmont Equipment & Technologies	1248
Carr Lane Manufacturing/ Carr Lane Roemheld	5659
EM Benson Co	5141
Erowa Technology Inc	1628
Fixtureworks	5766
Hardinge Inc	5444
Hermann Schmidt Co	1723
Hirschmann Engineering USA Inc	1231
Jergens Inc	5644
Kitagawa-NorthTech Inc.	1152
Koma Precision Inc	5359
Lang Technovation Co	5483
Mach 1 Systems Inc	1725
Mitee-Bite Products LLC	5459
Northfield Precision Instrument Corp	5508
PAWS Workholding	5866
R&R Fixtures LLC	3318
Ram Precision Tool Inc	1626
Roemheld	5661
Samchully Workholding	5469
Schunk Inc	5433
SMW Autoblok Corp	2013
Strong Hand Tools	5627
Syil America Inc	1808
TCI Precision Metals	5030
TE-CO	5463
TRIAG	5843
US Shop Tools	5609

Warehouse Equipment & Supplies

Acorn Industrial Products Co	5415
Ergo Advantage	5617
Fixtureworks	5766
General Manufacturing Inc	1863
GKS Lifting and Moving Solutions LLC	3325
MB Metal Technologies LLC	2009
Modula Inc	1254
Stor-Loc Corp	5712
W T Hight CO	3338

Washers Equipment & Supplies

Advanced Coating Service	5624
Blast & Wash Systems	5509
Branson Ultrasonics Corp	3235
Brush Research Manufacturing Co	5608
Chemetall US Inc	3234
Cleaning Technologies Group	3219
Crest Ultrasonics Corp	3058
Ebbco Inc	1727
Ecoclean Inc	3019
JRI/JenFab Wash Systems	5509
Ketcham & Co Inc	3306
LS Industries Inc	3043
Magido USA	1118, 1838
MCRL Inc / Fluid Chillers	1001
Mikro Industrial Finishing Co	5440
New England Metal Finishing & Precision Finishing Services	5136
New England Sales Inc	2026
Noble Industrial Furnace	3354
Pro Ultrasonics	3055
Rock Ridge Abrasives	5743
stratus technologies	5743
Takachiho America Inc.	5741

Waste Management

ACM Technologies	3124
Air Filtration Systems	3059
Automation Engineering Co	5759
Custom Service Solutions Inc	3218
Ebbco Inc	1727
Ketcham & Co Inc	3306
Mayfran	5469
Mikro Industrial Finishing Co	5440
New England Metal Finishing & Precision Finishing Services	5136
Pro Ultrasonics	3055
RUF Briquetting Systems	3023, 5759
Takachiho America Inc.	5741
UNTHA Shredding Technologies	5759
Walrus America Inc	5748
Weima America Inc	335

Waterjet Cutting Equipment & Systems

Acorn Industrial Products Co	5415
Aerospace Alloys Inc	5729
Aquajet Cutting Technology	1654
Brooks Assoc Inc	1206
Chapin & Bangs Steel Co/ Lindquist Steels Inc	5012
Ebbco Inc	1727
Flow International Corp	1712
Fluid Chillers	1001
Hypertherm	5743
Jet Edge	1770
KMT Waterjet Systems Inc	1344
Machitech Automation	1656
Mayfran	5469
MCRL Inc / Fluid Chillers	1001
OMAX Corp	1106
Penn Stainless Products Inc	5043
Rock Ridge Abrasives	5743

Waterjet Cutting Services

Aerospace Alloys Inc	5729
Aquajet Cutting Technology	1654
Brooks Assoc Inc	1206
Chapin & Bangs Steel Co/ Lindquist Steels Inc	5012
Flow International Corp	1712
Hypertherm	5743
Jet Edge	1770
KMT Waterjet Systems Inc	1344
MCRL Inc / Fluid Chillers	1001
Penn Stainless Products Inc	5043
Rock Ridge Abrasives	5743
US Tool Group Inc	5626
Yarde Metals Inc	2039

Wear Parts

Curbell Plastics Inc	5771
Laroche Foundry Ltd	5362
Plastics International	5366
Precision Punch Corp	5633
Wickman Machine Tool Inc	1822

Welding Systems Services & Supplies

Aimtek Inc	2108
Airgas	1656
Alpha Laser - US	2105
Amada Miyachi America	2101
Branson Ultrasonics Corp	3235
Cambridge Vacuum Engineering	5857
Ensitech Inc	5758
Fronius USA LLC	1737
General Manufacturing Inc	1863
Gesswein Co	5653
LaserStar Technologies Corp	2100
Miller Electric	1656
Praxair Distribution Inc.	1606
Precision Laser Technology LLC	3154
Preco Inc	5237
Radyne Corp	1102
Strong Hand Tools	5627
Taylor-Winfield Technologies Inc	2107

Wheel Dressers

A. TEC Diamond Co Ltd	5006
Advanced Superabrasives, Inc.	1156
Cool Grind Technologies	1745
Engis Corp	5028
G II Solutions Inc	1253
Hermann Schmidt Co	1723
Rush Machinery	1129
Saacke North America LLC	1156
Tru Tech Systems Inc	1830
Winslow Engineering Inc	2109

Wire Forming Equipment

J&S Machine Inc	5820
Radyne Corp	1102
Rapid Air	5523
SIMASV	5820

Workbench Equipment

Atlas Copco Tools/Palmac	1134
Dake	5469
Deluxe Systems	3340
Engis Corp	5028
Ergotronix Inc	5144
General Manufacturing Inc	1863
Gesswein Co	5653
Hermann Schmidt Co	1723
Starrett Company	3011, 5045
Stor-Loc Corp	5712
Strong Hand Tools	5627
Waldmann Lighting Co	1614
Workplace Modular Systems LLC	5658

Workholding Equipment & Accessories

Advanced Machine & Engineering	5843
AMF	5146
Belmont Equipment & Technologies	1248
Big Kaiser Precision Tooling Inc	5248
Blue Photon Technology & Workholding Systems LLC	5734
Butler Bros	5637
Carr Lane Manufacturing/ Carr Lane Roemheld	5659
Cutler Industrial Sales	5469

Emuge Corp	5369	MIDACO Corp	1858	Southwick & Meister Inc	5387
Ergotronix Inc	5144	Mitee-Bite Products LLC	5459	Strong Hand Tools	5627
Erowa Technology Inc	1628	Modern Industries Inc	5750	TE-CO	5463
Fixtureworks	5766	New England Metal Finishing & Precision Finishing Services	5136	The Robert E. Morris Company	5464
H & R	5469	Paletti USA	3239	TRIAG	5843
Halder Inc	5427	PAWS Workholding	5866	Vektek LLC	5026
Hardinge Inc	5444	Phillips Precision Inc	3342	Walker Magnetics	5543
Hermann Schmidt Co	1723	Platinum Tooling	5146	WTO USA	5223
Hirschmann Engineering USA Inc	1231	R&R Fixtures LLC	3318	Wrenches	
Huot Manufacturing	1118	Ram Precision Tool Inc	1626	Atlas Copco Tools/Palmac	1134
Huron Machine Products	5000	Roemheld	5661	EIGHT TOOL America	5647
INIRAM Precision Machine Tool Inc	1468	Royal Products	5469	iSwiss Corporation	5616
iSwiss Corporation	5616	Samchully Workholding	5469		
Jergens Inc	5644	Sauter North America Inc	5423		
Kitagawa-NorthTech Inc.	1152	Schunk Inc	5433		
Lang Technovation Co	5483	SMW Autoblok Corp	2013		
LaserStar Technologies Corp	2100	Somma Tool Co	5542		
Mach 1 Systems Inc	1725				

AD INDEX

Alpha Laser	56	JTEKT Toyoda Americas Corp	73	Sandvik Coromant Co	17
Belmont Equipment & Technologies	57	Kasto Inc	86	Siemens Industry Inc	39
BIG Kaiser Precision Tooling Inc	58	Kennametal Inc	3	SME	119
Blaser Swisslube Inc.	59	Koma Precision Inc	74	SME Education Foundation	96
Carr Lane Manufacturing Co	60	Kyocera Precision Tools Inc	75	SME Membership	51
Carr Lane Roemheld	19	Lang Technovation Co	76	SMW Autoblok Corp	88
CGTech	61	Manufacturing Technology Series	54	Somma Tool Co	86
Design-2-Part	63	Marposs Corp	77	Star CNC Machine Tool Corp / Eurotech Elite	87
Edge Technologies	35	Marubeni Citizen Cincom Inc	1	Throughput Consulting Inc	90
Erowa Technology Inc	65	Mastercam/CNC Software Inc	78	Trak Machine Tools	Cover 4
Fagor Automation Corp	29	Methods Machine Tools Inc	Cover 2	TRUMPF Inc	15
FANUC America Corp	66	Mitsubishi Electric Automation Inc	79	US Shop Tools	91
GF Machining Solutions	67	Northfield Precision	80	Vektek LLC	92
Gradient Lens Corporation	70	NSK America Corp	81	Verisurf Software Inc	25
Greenleaf Corp	68, 69	NTK Cutting Tools	53	Vlier	27
GWS Tool Group	31	OPEN MIND Technologies USA Inc.	82	Vlier	95
Haimer USA	21	OSG USA INC	23	Vollmer Of America	94
Heidenhain Corp	71	Platinum Tooling Technologies	9	Waldmann Lighting Co	46
Hirschmann Engineering USA Inc	72	Renishaw Inc	33	ZEISS Industrial Metrology	41
HORN USA Inc	Cover 3	Rollomatic Inc	85	Zoller Inc	93



ph HORN ph

PRECISION QUICK-CHANGE SWISS TOOLS

W&F MODULAR SYSTEM

HORN supplies cutting-edge technology, performance, and reliability. For long service life, precision, and effectiveness: our tools make the difference.

www.hornusa.com

Visit us at Booth 5353

TRAK[®] MACHINE TOOLS



SOUTHWESTERN INDUSTRIES, INC.

Visit Us at

eastec[®]

Booth #1434

Introducing the *amazing new*

ProtoTRAK RX SERIES



**Dozens of new, innovative features!
Exclusively on TRAK Bed Mills and Lathes**

- Touch Screen
- Advanced Graphics
- Brushless Servo Motors
- Manual TRAKing™
- ...and more!

Connect with us!



www.TrakMT.com | 800-421-6875

2615 Homestead Place, Rancho Dominguez, CA 90220